

FRENIC-Lift

LM2A series

- Three-phase 400 V : FRN0006LM2A-4□ to FRN0091LM2A-4□
- Single-phase 200 V : FRN0011LM2A-7□/FRN0018LM2A-7□

CAUTION

Thank you for purchasing our FRENIC-Lift LM2A series of inverters.

- This product is designed to drive three-phase induction motors and three-phase permanent magnet synchronous motors. Read through this manual to become familiar with the handling procedure and correct use.
- Improper handling might result in incorrect operation, short life cycle, or failure of this product as well as the motor.
- Deliver this manual to the end user of this product. Keep this manual in a safe place until this product is discarded.
- For instructions on how to use an optional device, refer to the instruction and installation manuals for that optional device.

Copyright © 2015 Fuji Electric Co., Ltd.

All rights reserved.

No part of this publication may be reproduced or copied without prior written permission from Fuji Electric Co., Ltd.

All products and company names mentioned in this manual are trademarks or registered trademarks of their respective holders.

The information contained herein is subject to change without prior notice for improvement.

Preface

Thank you for purchasing our FRENIC-Lift LM2A series of inverters.

FRENIC-Lift LM2A is an inverter designed to drive a three-phase induction motor (hereafter called induction motor) and a three-phase permanent magnet synchronous motor (hereafter called synchronous motor) for exclusively controlling elevating machinery.

Improper handling might result in incorrect operation, a short life, or even a failure of this product as well as the motor.

To drive a synchronous motor, a PG interface card option involving a pulse encoder is needed. For details, refer to the instruction manual of PG Interface Card.

This instruction manual is the original instructions and provides only minimum requisite information for wiring and operation of the product. Read through this manual before use.

For details about this product, refer to the FRENIC-Lift LM2A series Reference Manual that contains the precautions, detailed functions, specifications and configuration.

Related documentation

- FRENIC-Lift LM2A series Reference Manual
- TP-A1-LM2 Installation Manual

These materials are subject to change without notice. Be sure to obtain the latest editions for use.



We plan to make the latest edition of the User's Manual available for download from the following URL:

(URL) <https://felib.fujielectric.co.jp/download/index.htm?site=global&lang=en>

■ Safety precautions

Read this manual thoroughly before proceeding with installation, connections (wiring), operation, or maintenance and inspection. Ensure you have sound knowledge of the device and familiarize yourself with all safety information and precautions before proceeding to operate the inverter.

Safety precautions are classified into the following two categories in this manual.

 WARNING	Failure to heed the information indicated by this symbol may lead to dangerous conditions, possibly resulting in death or serious bodily injuries.
 CAUTION	Failure to heed the information indicated by this symbol may lead to dangerous conditions, possibly resulting in minor or light bodily injuries and/or substantial property damage.

Failure to heed the information contained under the CAUTION title can also result in serious consequences. These safety precautions are of utmost importance and must be observed at all times.

Application

 WARNING
<ul style="list-style-type: none">• FRENIC-Lift is equipment designed to drive induction motors and synchronous motors for exclusively controlling elevating machinery. Do not use it for single-phase motors or for other purposes. Fire or an accident could occur.• This product may not be used for a life-support system or other purposes directly related to the human safety.• Although product is manufactured under strict quality control, install safety devices for applications where serious accidents or property damages are foreseen in relation to the failure of it. An accident could occur.

Installation

WARNING

- Install the inverter on a base made of metal or other non-flammable material.
Otherwise, a fire could occur.
- Do not place flammable object nearby.
Doing so could cause fire.

CAUTION

- Do not support the inverter by its front cover during transportation.
Doing so could cause a drop of the inverter and injuries.
- Prevent lint, paper fibers, sawdust, dust, metallic chips, or other foreign materials from getting into the inverter or from accumulating on the heat sink.
- When changing the positions of the top and bottom mounting bases, use only the specified screws.
Otherwise, a fire or an accident might result.
- Do not install or operate an inverter that is damaged or lacking parts.
Doing so could cause fire, an accident or injuries.

Wiring

WARNING

- If there isn't zero-phase current (Earth leakage current) detective device, such as a ground-fault relay in the upstream power supply line, which is to avoid undesirable system shutdown. Install a residual-current-operated protective device (RCD)/earth leakage circuit breaker (ELCB) individually to break the individual inverter's power supply line.
Otherwise, a fire could occur.
- When wiring the inverter to the power source, insert a recommended molded case circuit breaker (MCCB) or residual-current-operated protective device (RCD)/earth leakage circuit breaker (ELCB) (with overcurrent protection) in the path of each pair of power lines to inverters. Use the recommended devices within the recommended current capacity.
- Use wires in the specified size.
- Tighten terminals with specified torque.
Otherwise, a fire could occur.
- When there is more than one combination of an inverter and motor, do not use a multicore cable for the purpose of running their wirings together.
- Do not connect a surge killer to the inverter's output (secondary) circuit.
Doing so could cause a fire.
- Be sure to ground the inverter's grounding terminals G.
Otherwise, an electric shock or a fire could occur.
- Qualified electricians should carry out wiring.
- Be sure to perform wiring after turning the power OFF.
Otherwise, an electric shock could occur.
- Be sure to perform wiring after installing the inverter unit.
Otherwise, an electric shock or injuries could occur.

WARNING

- Ensure that the number of input phases and the rated voltage of the product match the number of phases and the voltage of the AC power supply to which the product is to be connected.
Otherwise, a fire or an accident could occur.
- Do not connect the power supply wires to the inverter output terminals (U, V, and W).
Doing so could cause fire or an accident.
- In general, sheaths of the control signal wires are not specifically designed to withstand a high voltage (i.e., reinforced insulation is not applied). Therefore, if a control signal wire comes into direct contact with a live conductor of the main circuit, the insulation of the sheath might break down, which would expose the signal wire to a high voltage of the main circuit. Make sure that the control signal wires will not come into contact with live conductors of the main circuit.
Doing so could cause an accident or an electric shock.

WARNING

- Before changing the switches, **turn OFF the power and wait at least 10 minutes**. Make sure that the charging lamp is turned OFF. Further, make sure, using a multimeter or a similar instrument, that the DC link bus voltage between the terminals P(+) and N(-) has dropped to the safe level (+25 VDC or below).
Otherwise, an electric shock could occur.

CAUTION

- The inverter, motor and wiring generate electric noise. Be careful about malfunction of the nearby sensors and devices. To prevent them from malfunctioning, implement noise control measures.
Otherwise an accident could occur.
- The leakage current of FRENIC-Lift is comparatively large for the EMC filter built-in type of inverters. Be sure to perform protective grounding.
Otherwise, an accident or an electric shock could occur.

Operation

WARNING

- Be sure to mount the front cover before turning the power ON. Do not remove the cover when the inverter power is ON.
Otherwise, an electric shock could occur.
- Do not operate switches with wet hands.
Doing so could cause electric shock.
- If the auto-reset function has been selected, the inverter may automatically restart and drive the motor depending on the cause of tripping. Design the machinery or equipment so that human safety is ensured at the time of restarting.
Otherwise, an accident could occur.
- If any of the protective functions have been activated, first remove the cause. Then, after checking that all the run commands are set to OFF, release the alarm. If the alarm is released while any run commands are set to ON, the inverter may supply the power to the motor, running the motor.
Otherwise, an accident could occur.

WARNING

- If the user configures the function codes wrong without completely understanding this Instruction Manual and the FRENIC-Lift LM2A series Reference Manual, the motor may rotate with a torque or at a speed not permitted for the machine.

An accident or injuries could occur.

- Even if the inverter has interrupted power to the motor, if the voltage is applied to the main circuit input terminals L1/R, L2/S and L3/T, voltage may be output to inverter output terminals U, V, and W.
- Even if the motor is stopped due to DC braking, voltage is output to inverter output terminals U, V, and W.

An electric shock may occur.

- The inverter can easily accept high-speed operation. When changing the speed setting, carefully check the specifications of motors or equipment beforehand.

Otherwise, injuries could occur.

CAUTION

- Do not touch the heat sink because it becomes very hot.

Doing so could cause burns.

- The DC brake function of the inverter does not provide any holding mechanism.

Injuries could occur.

- Ensure safety before modifying customizable logic related function code settings (U codes and related function codes) or turning ON the "Cancel customizable logic" terminal command **CLC**. Depending upon the settings, such modification or cancellation of the customizable logic may change the operation sequence to cause a sudden motor start or an unexpected motor operation.

- If any abnormality is found in the inverter or motor, immediately stop it and perform troubleshooting, referring to the FRENIC-Lift LM2A series Reference Manual.

An accident or injuries could occur.

Maintenance and inspection, and parts replacement

WARNING

- Before proceeding to maintenance or inspection, **turn OFF the power and wait at least 10 minutes.** Make sure that the charging lamp is turned OFF. Further, make sure, using a multimeter or a similar instrument, that the DC link bus voltage between the terminals P(+) and N(-) has dropped to the safe level (+25 VDC or below).

Otherwise, an electric shock could occur.

- Always carry out the daily and periodic inspections described in the this manual. Use of the inverter for long periods of time without carrying out regular inspections could result in malfunction or damage, and an accident or fire could occur.
- It is recommended that periodic inspections be carryout every one to two years, however, they should be carried out more frequently depending on the usage conditions.
- It is recommended that parts for periodic replacement be replaced in accordance with the standard replacement frequency indicated in the this manual. Use of the product for long periods of time without replacement could result in malfunction or damage, and an accident or fire could occur.
- Contact outputs [30A/B/C] [Y5A/C] [Y4A/C] [Y3A/C] use relays, and may remain ON, OFF, or undetermined when their lifetime is reached. In the interests of safety, equip the inverter with an external protective function.

Fire or an accident could occur.

- Maintenance, inspection, and parts replacement should be made only by qualified persons.
- Take off the watches, rings and other metallic objects before starting work.
- Use insulated tools.

Otherwise, an electric shock or injuries could occur.

- Never modify the inverter.

Doing so could cause an electric shock or injuries.

Disposal

CAUTION

- Treat the inverter as an industrial waste when disposing of it.

Otherwise injuries could occur.

GENERAL PRECAUTIONS

Drawings in this manual may be illustrated without covers or safety shields for explanation of detail parts. Restore the covers and shields in the original state and observe the description in the manual before starting operation.

Icons

The following icons are used throughout this manual.



This icon indicates information which, if not heeded, can result in the inverter not operating to full efficiency, as well as information concerning incorrect operations and settings which can result in accidents.



This icon indicates information that can prove handy when performing certain settings or operations.



This icon indicates a reference to more detailed information.

Conformity to the Low Voltage Directive in the EU

If installed according to the guidelines given below, inverters marked with CE are considered as compliant with the Low Voltage Directive.

Compliance with European Standards

Adjustable speed electrical power drive systems (PDS).

Part 5-1: Safety requirements. Electrical, thermal and energy. IEC/EN 61800-5-1

⚠ WARNING ⚠

- The ground terminal  G should always be connected to the ground. Do not use only a residual-current-operated protective device (RCD)/earth leakage circuit breaker (ELCB)* as the sole method of electric shock protection. Be sure to use ground wires of recommended size listed on page vii.
*With overcurrent protection.
- To prevent the risk of hazardous accidents that could be caused by damage of the inverter, install the specified fuses in the supply side (primary side) according to the following tables.
 - Breaking capacity: Min. 10 kA
 - Rated voltage: Min. 500 V

Power supply voltage	Nominal applied motor (kW)	Inverter type	Fuse rating [A] (Class)	
			With DCR	Without DCR
Three-phase 400 V	2.2	FRN0006LM2A-4□	10 (IEC/EN 60269-2)	15 (IEC/EN 60269-2)
	4.0	FRN0010LM2A-4□	15 (IEC/EN 60269-2)	20 (IEC/EN 60269-2)
	5.5	FRN0015LM2A-4□	20 (IEC/EN 60269-2)	30 (IEC/EN 60269-2)
	7.5	FRN0019LM2A-4□	30 (IEC/EN 60269-2)	40 (IEC/EN 60269-2)
	11	FRN0025LM2A-4□	40 (IEC/EN 60269-2)	- *2
	15	FRN0032LM2A-4□	60 (IEC/EN 60269-2)	- *2
	18.5	FRN0039LM2A-4□	160 (IEC/EN 60269-4)	
	22	FRN0045LM2A-4□		
	30	FRN0060LM2A-4□	250 (IEC/EN 60269-4)	
	37	FRN0075LM2A-4□	315 (IEC/EN 60269-4)	
45	FRN0091LM2A-4□			
Single-Phase 200V	2.2	FRN0011LM2A-7□	30 (IEC/EN 60269-2)	40 (IEC/EN 60269-2)
	4.0	FRN0018LM2A-7□	60 (IEC/EN 60269-2)	80 (IEC/EN 60269-2)

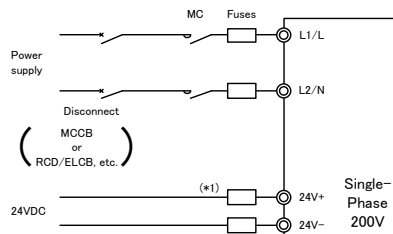
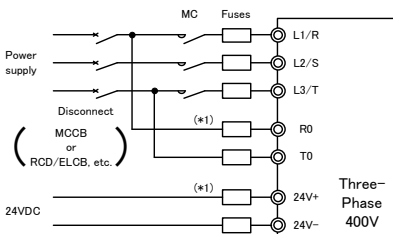

Note: A box (□) replaces an alphabetic letter depending on the shipping destination.

□Shipping destination: E (Europe) or A (Asia)

*1) Not more than 6A (RMS) fuses or not more than 5A (RMS) breakers for 24V power supply and control power supply (R0 and T0). Fuse class: IEC/EN 60269-1 or 60269-2

*2) The recommended fuse type is applicable to the inverter equipped with a DC reactor. Be sure to use a DC reactor.

Conformity to the Low Voltage Directive in the EU (Continued)



3. When used with the inverter, a molded case circuit breaker (MCCB), residual-current-operated protective device (RCD)/earth leakage circuit breaker (ELCB) or magnetic contactor (MC) should conform to the EN or IEC standards.
4. When you use a residual-current-operated protective device (RCD)/earth leakage circuit breaker (ELCB) for protection from electric shock in direct or indirect contact power lines or nodes, be sure to install type B of RCD/ELCB on the input (primary) of the inverter.
5. The inverter should be used in an environment that does not exceed Pollution Degree 2 requirements. If inverters are to be used in an environment with pollution Degree 3 or 4, place them in an enclosure of IP54 or above.
6. Install the inverter, Reactor, input or output filter in an enclosure with minimum degree of protection of IP2X (Top surface of enclosure shall be minimum IP4X when it can be easily accessed), to prevent human body from touching directly to live parts of these equipment.
7. Do not connect any copper wire directly to grounding terminals. Use crimp terminals with tin or equivalent plating to connect them.
8. When you use an inverter at an altitude of more than 2000 m, you should apply basic insulation for the control circuits of the inverter. The inverter cannot be used at altitudes of more than 3000 m.
9. Use wires listed in IEC 60364-5-52.

Power supply voltage	Nominal applied motor (kW)	Inverter type	Recommended copper wire size (mm ²)						
			Main terminal *1		External braking resistor connection [DB, P(+)] *1	Inverter outputs for Short circuit [U0, V0, W0] *1	Control circuit	control power supply [24V+, -]	Aux main power supply [R0, T0] *1
			Main power input	Inverter outputs [U, V, W]					
			Inverter's grounding [EG]						
Three-phase 400 V	2.2	FRN0006LM2A-4□	10	2.5	2.5	2.5	0.75	-	
	4.0	FRN0010LM2A-4□							
	5.5	FRN0015LM2A-4□							
	7.5	FRN0019LM2A-4□							
	11	FRN0025LM2A-4□							
	15	FRN0032LM2A-4□							
	16.5	FRN0039LM2A-4□	16	10	4	0.75	-		
	22	FRN0045LM2A-4□							
	30	FRN0060LM2A-4□							
	37	FRN0075LM2A-4□							
45	FRN0091LM2A-4□	50	35	10	35	16	2.5		
Single-phase 200V	2.2	FRN0011LM2A-7□	10	2.5	2.5	2.5	0.75	0.75	-
	4.0	FRN0018LM2A-7□		4					

Power supply voltage	Nominal applied motor (kW)	Inverter type	Recommended copper wire size (mm ²)			
			Main terminal *1		DC reactor connection [P2,P3] [P1, P(+)] *1	
			Main power input [L1/R, L2/S, L3/T]			
			With DCR	Without DCR	With DCR	Without DCR
Three-phase 400 V	2.2	FRN0006LM2A-4□	2.5	2.5	2.5	2.5
	4.0	FRN0010LM2A-4□				4
	5.5	FRN0015LM2A-4□				6
	7.5	FRN0019LM2A-4□	4	6	10	16
	11	FRN0025LM2A-4□	6	10	6	16
	15	FRN0032LM2A-4□	6	16	10	- *2
	18.5	FRN0039LM2A-4□	10	25	16	
	22	FRN0045LM2A-4□	16	35	25	
	30	FRN0060LM2A-4□	25	50	35	
	37	FRN0075LM2A-4□	25	50	35	
45	FRN0091LM2A-4□	25	50	35	35	
Single-phase 200V	2.2	FRN0011LM2A-7□	2.5	4	2.5	4
	4.0	FRN0018LM2A-7□	6	-	6	-

Note: A box (□) replaces an alphabetic letter depending on the shipping destination.

□Shipping destination: E (Europe) or A (Asia)

*1 The recommended wire size for main circuits is for the 70°C 600 V PVC sheath wires used at an ambient temperature of 40°C.

*2 Use installed shorting bar.

Conformity to the Low Voltage Directive in the EU (Continued)



10. The inverter has been tested according to IEC/EN 61800-5-1 Short-circuit Test under the following conditions.

Short-circuit current in the supply: 10,000 A

480V or below (400V class series inverters)

240V or below (200V class series inverters)

11. Use this inverter at the following power supply system.

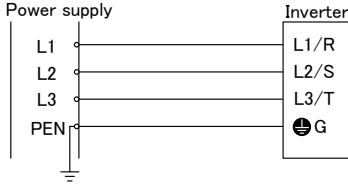

TN-C system

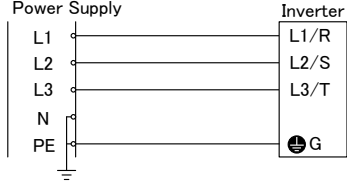

TN-S system

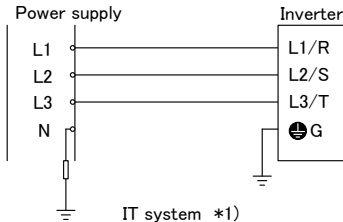

IT system *1)

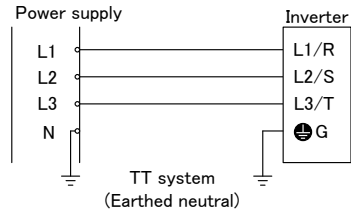

TT system
(Earthed neutral)

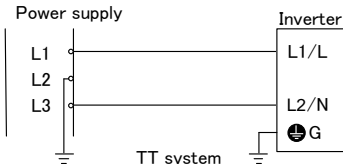

TT system
(corner earthed/phase-earthed)
(Applicable for 200V type only) *2)

*1 Use this inverter at the following IT system.

Non-earthed (isolated from earth) IT system	Can be used. In this case the insulation between the control interface and the main circuit of the inverter is basic insulation. Thus do not connect SELV circuit from external controller directly (make connection using a supplementary insulation.).
IT system which earthed neutral by an impedance	
Corner earthed / Phase-earthed IT system by an impedance	Cannot be used

*2 Cannot apply to Corner earthed / Phase-earthed TT system except 200V type.

Conformity with Canadian standards and U.S. standards

The inverters with CSA "C/US" marking are subject to the regulations set forth by the Canadian and U.S. standards by installation within precautions listed below.

CAUTION

1. Solid state motor overload protection (motor protection by electronic thermal overload relay) is provided in each model. Use function codes F10 to F12 to set the protection level.

2. Short circuit rating

Suitable for use on a circuit capable of delivering not more than 10,000 rms symmetrical amperes, 240 Volts maximum when protected by fuses having an interrupting rating not less than 10,000 rms symmetrical amperes, 240 Volts maximum. Models FRN: rated for 200 V class input.

CONVIENT AUX CIRCUITS NON SUSCEPTIBLES DE DÉLIVRER PLUS DE 10,000 AMPÈRES SYMÉTRIQUES EFF., MAXIMUM 240 V

Suitable for use on a circuit capable of delivering not more than 10,000 rms symmetrical amperes, 480 Volts maximum when protected by circuit breaker having an interrupting rating not less than 10,000 rms symmetrical amperes, 480 Volts maximum. Models FRN: rated for 400 V class input.

CONVIENT AUX CIRCUITS NON SUSCEPTIBLES DE DÉLIVRER PLUS DE 10,000 AMPÈRES SYMÉTRIQUES EFF., MAXIMUM 480 V

Branch Circuit Protection must be provided by the end user, sized per the Canadian Electrical Code, Part I, the National Electrical Code and all applicable local codes.

INTEGRAL SOLID STATE SHORT CIRCUIT PROTECTION DOES NOT PROVIDE BRANCH CIRCUIT PROTECTION. BRANCH CIRCUIT PROTECTION MUST BE PROVIDED IN ACCORDANCE WITH THE CANADIAN ELECTRICAL CODE, PART I.

LA PROTECTION INTÉGRÉE CONTRE LES COURTSCIRCUITS N'ASSURE PAS LA PROTECTION DE LA DÉRIVATION. LA PROTECTION DE LA DÉRIVATION DOIT ÊTRE EXÉCUTÉE CONFORMÉMENT AU CODE CANADIEN DE L'ÉLECTRICITÉ, PREMIÈRE PARTIE.

3. Environmental Requirements

- Surrounding/ ambient temperature

Maximum Surrounding Air Temperature 45 °C

- Area of Use

For use in pollution degree 2 environments and overvoltage category III.

Conformity with Canadian standards and U.S. standards (Continued)



4. Use wires listed in CSA or UL.

Power supply voltage	Nominal applied motor (kW)	Inverter type	Recommended copper wire size AWG (mm ²)							
			Main terminal *1		External braking resistor connection [DB, P(+)] *1	Inverter outputs for Short circuit [U0, V0, W0] *1	Control circuit	control power supply [24V(+,-)]	Aux main power supply [R0, T0] *1	
			Main power input	Inverter outputs [U, V, W]						
Three-phase 400 V	2.2	FRN0006LM2A-4□	6 (13.3)	14 (2.1)	14 (2.1)	14 (2.1)	18 (0.8)	-		
	4.0	FRN0010LM2A-4□								
	5.5	FRN0015LM2A-4□								
	7.5	FRN0019LM2A-4□								
	11	FRN0025LM2A-4□								
	15	FRN0032LM2A-4□								
	18.5	FRN0039LM2A-4□	4 (21.2)	6 (13.3)	10 (5.3)	18 (0.8)	-			
	22	FRN0045LM2A-4□								
	30	FRN0060LM2A-4□	3 (26.7)	4 (21.2)	6 (13.3)	14 (2.1)	18 (0.8)	12 (3.3)		
	37	FRN0075LM2A-4□	1 (42.4)							
	45	FRN0091LM2A-4□	1/0 (53.5)						3 (26.7)	4 (21.2)
Single-phase 200 V	2.2	FRN0011LM2A-7□	8 (8.4)	14 (2.1)	14 (2.1)	14 (2.1)	18 (0.8)	18 (0.8)		
	4.0	FRN0018LM2A-7□		12 (3.3)						

Power supply voltage	Nominal applied motor (kW)	Inverter type	Recommended copper wire size AWG (mm ²)			
			Main terminal *1		DC reactor connection [P2,P3] [P1, P(+)] *1	
			Main power input [L1/R, L2/S, L3/T]			
			With DCR	Without DCR	With DCR	Without DCR
Three-phase 400 V	2.2	FRN0006LM2A-4□	14 (2.1)	14 (2.1)	14 (2.1)	14 (2.1)
	4.0	FRN0010LM2A-4□		12 (3.3)		12 (3.3)
	5.5	FRN0015LM2A-4□		10 (5.3)	12 (3.3)	10 (5.3)
	7.5	FRN0019LM2A-4□	12 (3.3)		10 (5.3)	8 (8.4)
	11	FRN0025LM2A-4□	10 (5.3)	8 (8.4)	8 (8.4)	6 (13.3)
	15	FRN0032LM2A-4□	8 (8.4)	6 (13.3)		
	18.5	FRN0039LM2A-4□			6 (13.3)	3 (26.7)
	22	FRN0045LM2A-4□	6 (13.3)	4 (21.2)		
	30	FRN0060LM2A-4□	4 (21.2)	3 (26.7)		
	37	FRN0075LM2A-4□	3 (26.7)	1 (42.4)		
45	FRN0091LM2A-4□	2 (33.6)	1/0 (53.5)	1 (42.4)		
Single-phase 200 V	2.2	FRN0011LM2A-7□	10 (5.3)	10 (5.3)	10 (5.3)	10 (5.3)
	4.0	FRN0018LM2A-7□	8 (8.4)	-	8 (8.4)	-

Note: A box (□) replaces an alphabetic letter depending on the shipping destination.

□Shipping destination: E (Europe) or A (Asia)

*1 Use Cu wire only. The recommended wire size for main circuits is for the 75 °C.

*2 Use installed shorting bar.

Conformity with Canadian standards and U.S. standards (Continued)

⚠ CAUTION

5. Install CSA or UL certified fuses or Circuit breaker between the power supply and the inverter, referring to the table below.

Power supply voltage	Nominal applied motor (kW)	Inverter type	Fuse rating [A] (Class)		Circuit breaker (MCCB) or RCD/ELCB etc [A]	
			With DCR	Without DCR	With DCR	Without DCR
Three-phase 400 V	2.2	FRN0006LM2A-4□			10	
	4.0	FRN0010LM2A-4□				
	5.5	FRN0015LM2A-4□				
	7.5	FRN0019LM2A-4□				
	11	FRN0025LM2A-4□			15	
	15	FRN0032LM2A-4□				
	18.5	FRN0039LM2A-4□			20	
	22	FRN0045LM2A-4□				
	30	FRN0060LM2A-4□			30	
	37	FRN0075LM2A-4□				
45	FRN0091LM2A-4□	40	75			
Single-Phase 200V	2.2	FRN0011LM2A-7□	30 (Class J)	40 (Class J)		
	4.0	FRN0018LM2A-7□	60 (Class J)	80 (Class J)		

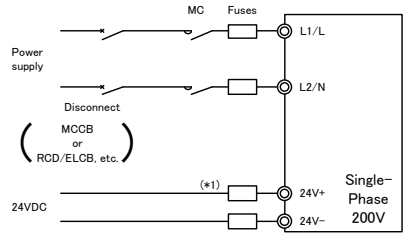
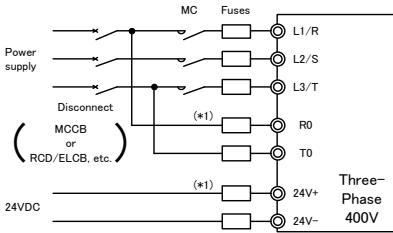

Note: A box (□) replaces an alphabetic letter depending on the shipping destination.
 □ Shipping destination: E (Europe) or A (Asia)

*1) Not more than 6A (RMS) fuses or not more than 5A (RMS) breakers for 24V power supply and control power supply (R0 and T0).

Product warranty

To all our customers who purchase Fuji Electric products included in this documentation:

Please take the following items into consideration when placing your order.

When requesting an estimate and placing your orders for the products described in this document, please be aware that any items such as specifications which are not specifically mentioned in the contract, catalog, specifications or other materials will be as mentioned below.

In addition, the products described in this document are limited in the use they are put to and the place where they can be used, etc., and may require periodic inspection. Please confirm these points with your sales representative or directly with this company.

Furthermore we request that you inspect the purchased and delivered products at the time of delivery. Also, prepare the area for installation of the inverter.

[1] Free of charge warranty period and warranty range

(1) Free of charge warranty period

- 1) The product warranty period is "1 year from the date of purchase" or 24 months from the manufacturing date imprinted on the nameplate, whichever date is earlier.
- 2) However, in cases where the installation environment, conditions of use, frequency or use and times used, etc., have an effect on product life, this warranty period may not apply.
- 3) Furthermore, the warranty period for parts repaired by Fuji Electric's Service Department is "6 months from the date that repairs are completed."

(2) Warranty range

- 1) In the event that breakdown occurs during the product's warranty period which is the responsibility of Fuji Electric, Fuji Electric will replace or repair the part of the product that has broken down free of charge at the place where the product was purchased or where it was delivered. However, if the following cases are applicable, the terms of this warranty may not apply.

- ① The breakdown was caused by the installation conditions, environment, handling or methods of use, etc. which are not specified in the catalog, operation manual, specifications or other relevant documents.
- ② The breakdown was caused by a product other than the purchased or delivered Fuji's product.
- ③ The breakdown was caused by a product other than Fuji's product, such as the customer's equipment or software design, etc.
- ④ Concerning the Fuji's programmable products, the breakdown was caused by a program other than a program supplied by this company, or the results from using such a program.
- ⑤ The breakdown was caused by modifications or repairs affected by a party other than Fuji Electric.
- ⑥ The breakdown was caused by improper maintenance or replacement of replaceable items, etc. specified in the operation manual or catalog, etc.
- ⑦ The breakdown was caused by a scientific or technical or other problem that was not foreseen when making practical application of the product at the time it was purchased or delivered.
- ⑧ The product was not used in the manner the product was originally intended to be used.
- ⑨ The breakdown was caused by a reason which Fuji Electric is not responsible, such as lightning or other disaster.

- 2) Furthermore, the warranty specified herein shall be limited to the purchased or delivered product alone.

- 3) The upper limit for the warranty range shall be as specified in item (1) above and any damages (damage to or loss of machinery or equipment, or lost profits from the same, etc.) consequent to or resulting from breakdown of the purchased or delivered product shall be excluded from coverage by this warranty.

(3) Trouble diagnosis

As a rule, the customer is requested to carry out a preliminary trouble diagnosis. However, at the customer's request, this company or its service network can perform the trouble diagnosis on a chargeable basis. In this case, the customer is asked to assume the burden for charges levied in accordance with this company's fee schedule.

Product warranty

[2] Exclusion of liability for loss of opportunity, etc.

Regardless of whether a breakdown occurs during or after the free of charge warranty period, this company shall not be liable for any loss of opportunity, loss of profits, or damages arising from special circumstances, secondary damages, accident compensation to another company, or damages to products other than this company's products, whether foreseen or not by this company, which this company is not responsible for causing.

[3] Repair period after production stop, spare parts supply period (holding period)

Concerning models (products) which have gone out of production, this company will perform repairs for a period of 7 years after production stop, counting from the month and year when the production stop occurs. In addition, we will continue to supply the spare parts required for repairs for a period of 7 years, counting from the month and year when the production stop occurs. However, if it is estimated that the life cycle of certain electronic and other parts is short and it will be difficult to procure or produce those parts, there may be cases where it is difficult to provide repairs or supply spare parts even within this 7-year period. For details, please confirm at our company's business office or our service office.

[4] Transfer rights

In the case of standard products which do not include settings or adjustments, the products shall be transported to and transferred to the customer and this company shall not be responsible for local adjustments or trial operation.

[5] Service contents

The cost of purchased and delivered products does not include the cost of dispatching engineers or service costs. Depending on the request, these can be discussed separately.

[6] Applicable scope of service

Above contents shall be assumed to apply to transactions and use in the country where you purchased the products.

Consult your local supplier or Fuji Electric representative for details.

Table of Contents

Preface.....	i
Safety precautions	i
Conformity to the Low Voltage Directive in the EU.....	vi
Conformity with Canadian standards and U.S. standards.....	x
Product warranty	xiv
Chapter 1 BEFORE USE	1-1
1.1 Acceptance Inspection and Appearance of Product	1-1
1.2 Precautions for Using Inverters.....	1-4
1.3 Usage environment and Storage environment	1-4
1.3.1 Usage environment.....	1-4
1.3.2 Storage environment.....	1-6
Chapter 2 MOUNTING AND WIRING THE INVERTER ..	2-1
2.1 Installing the Inverter	2-1
2.2 Wiring	2-2
2.2.1 Removing the front cover	2-2
2.2.2 Mounting the front cover	2-2
2.2.3 Recommended wire sizes	2-3
2.2.4 Terminal arrangement diagrams and screw specifications	2-3
2.2.5 Terminal functions and wiring order.....	2-7
2.2.6 Connection diagrams	2-13
2.2.7 Setting the slide switches on the control PCB	2-17
2.2.8 Mounting and connecting the keypad to the panel.....	2-17
Chapter 3 OPERATION USING THE KEYPAD.....	3-1
Chapter 4 RUNNING THE MOTOR FOR A TEST.....	4-1
4.1 Checking Prior to Powering ON.....	4-1
4.2 Powering ON and Checking	4-1
4.3 Configuring the Function Code Data Before Test Run	4-2
4.4 Running the Inverter for Motor Operation Check...	4-3
4.5 Preparation for Practical Operation.....	4-3
Chapter 5 TROUBLESHOOTING	5-1
5.1 Alarm Codes.....	5-1
Chapter 6 MAINTENANCE AND INSPECTION	6-1
6.1 Daily Inspection	6-1
6.2 Periodic Inspection	6-1
6.3 List of Periodic Replacement Parts.....	6-2
6.4 Inquiries about Product and Guarantee	6-3
6.4.1 When making an inquiry.....	6-3
Chapter 7 SPECIFICATIONS.....	7-1
7.1 Standard Model.....	7-1
7.2 External Dimensions	7-8
Chapter 8 CONFORMITY WITH STANDARDS	8-1
8.1 Compatibility with Revised EMC Directive and Low Voltage Directive	8-1
8.2 Compliance with European Standards.....	8-2
8.3 Conformity to the Low Voltage Directive in the EU	8-2
8.4 Compliance with EMC Standards	8-3
8.4.1 General	8-3
8.4.2 Recommended installation procedure.....	8-3
8.4.3 Leakage current of the EMC filter	8-4
8.5 Harmonic Component Regulation in the EU	8-5
8.5.1 General comments.....	8-5
8.5.2 Compliance with IEC/EN 61000-3-2.....	8-5
8.6 Compliance with Functional Safety Standard	8-6
8.6.1 General	8-6
8.6.2 Notes for compliance to Functional Safety Standard	8-8
8.6.3 Inverter output state when Safe Torque Off (STO) is activated	8-10
8.6.4 ECF alarm (caused by logic discrepancy) and inverter output state	8-12
8.7 Compliance with Canadian and U.S. Standards (CSA certification).....	8-13
8.7.1 General	8-13
8.7.2 Considerations when using FRENIC-Lift (LM2A)	

in systems to be certified by CSA..... 8-13

MEMO





Chapter 1 BEFORE USE

1.1 Acceptance Inspection and Appearance of Product

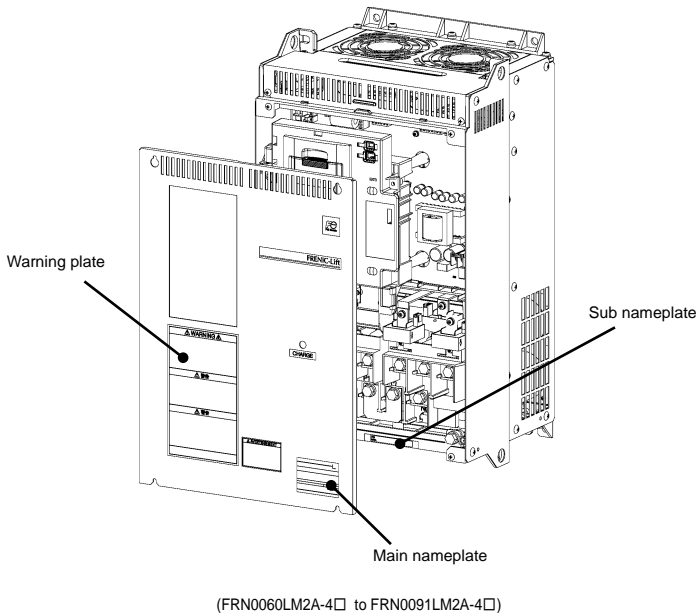
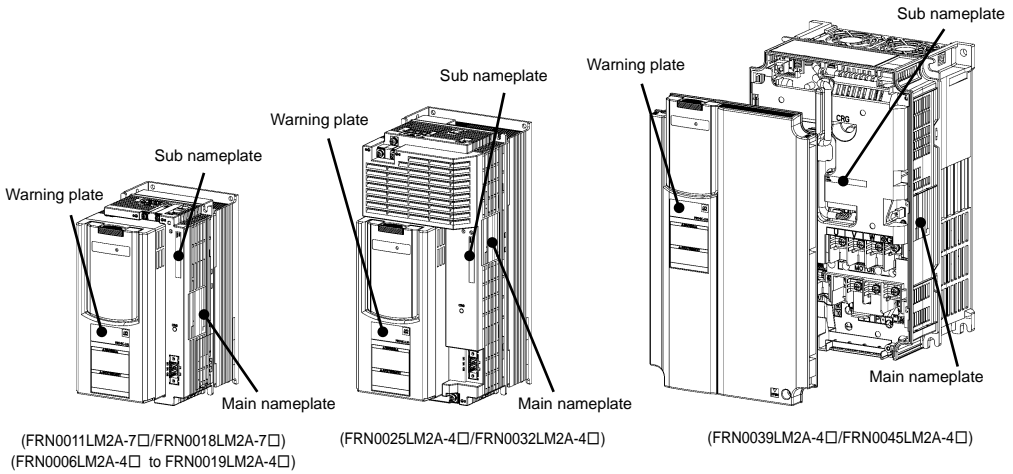
Unpack the package and check the following:

- (1) An inverter and the following accessories are contained in the package.
Instruction manual (this book)
Main circuit wiring connector
- (2) The inverter has not been damaged during transportation—there should be no dents or parts missing.
- (3) The inverter is the type you ordered. You can check the type and specifications on the main nameplate. (A total of two nameplates and warning plates are attached to the inverter as shown below.)



	Fuji Electric			Production year and week
Inverter type	TYPE	FRN0019LM2A-4E		048 Production week The 1st week of January is indicated as '01'. Production year: Last digit of year
Input power specifications	SOURCE	3PH 380-480V 50Hz/60Hz 23.2A		
Inverter output specifications	OUTPUT	3PH 380-480V 0-200Hz 14kVA 18.5A 200% 3sec		
Enclosure	IP Code	IP20		
Product number	SER.No.	W0ZA123A0001Z	048	
		  	Fuji Electric Shunan, Mar (81)-8633 Japan	Mass of the inverter
			MASS 4.7kg	

Main nameplate

FRENIC-Lift
⚠ WARNING ⚠
<ul style="list-style-type: none"> • RISK OF INJURY OR ELECTRIC SHOCK • Refer to the instruction manual before installation and operation. • Do not remove any cover while applying power and at least 5min. after disconnecting power. • Securely ground (earth) the equipment. • High touch current.
⚠ AVERTISSEMENT ⚠
<ul style="list-style-type: none"> • RISQUE DE BLESSURE OU DE CHOC ÉLECTRIQUE • Ne retirez pas le couvercle lorsque vous mettez sous tension. • Ce couvercle peut être retiré au moins 5 minutes après la mise hors tension et quand le témoin « ACTIF » s'éteint. • Plus d'un circuit électrique actif. Reportez-vous au manuel d'installation.
Only type B of RCD is allowed. See manual for details.

Warning plate

(FRN0011LM2A-7□/FRN0018LM2A-7□)
(FRN0006LM2A-4□ to FRN0045LM2A-4□)

TYPE	FRN0019LM2A-4E
SER.No.	W0ZA123A0001Z

Sub nameplate

⚠ WARNING ⚠
<ul style="list-style-type: none"> ■ RISK OF INJURY OR ELECTRIC SHOCK • Refer to the instruction manual before installation and operation. • Do not remove this cover while applying power. • This cover can be removed after at least 10 min of power off and after the "CHARGE" lamp turns off. • More than one live circuit. See instruction manual. • Do not insert fingers or anything else into the inverter. • Securely ground (earth) the equipment. • High touch current.
⚠ 警告
<ul style="list-style-type: none"> ■ 有可能引起受伤、触电 • 安装运行之前请务必阅读操作说明书并遵照其指示 • 通电中不要打开表面盖板 • 断电10分钟以上、充电指示灯熄灭后方可打开表面盖板 • 打开表盖时、要确认已经切断各路的辅助电源（请参考说明书） • 即使在安装了表面盖板时、也不要从缝隙间插入手指或其他异物 • 请正确接地
⚠ 警告
<ul style="list-style-type: none"> ■ けが、感電のおそれあり • 据え付け運転の前に、必ず取扱説明書を読んでその指示に従うこと。 • 通電中は、表面カバーを開けないこと。 • 表面カバーを開ける場合は、電源しや断後10分以上経過後チャージランプが消灯したのを確認してから行うこと。 • 表面カバーを開ける場合は、各補助電源もしや断していることを確認してから行うこと（取扱説明書を参照のこと）。 • 表面カバー取付状態であっても、開口部より装置内部に指、異物等挿入しないこと。 • 確実に接地をおこなうこと。
Only type B of RCD is allowed. See manual for details.

Warning plate

(FRN0060LM2A-4□ to FRN0091LM2A-6□)

⚠ AVERTISSEMENT ⚠
<ul style="list-style-type: none"> ■ RISQUE DE BLESSURE OU DE CHOC ÉLECTRIQUE • Ne retirez pas le couvercle lorsque vous mettez sous tension. • Ce couvercle peut être retiré au moins 10 minutes après la mise hors tension et quand le témoin « ACTIF » s'éteint. • Plus d'un circuit électrique actif. Reportez-vous au manuel d'installation.

FRN 0019 LM 2 A - 4 E

Code	Series name
FRN	FRENIC series

3PH 400V

Code	Output rated current
0006	6.1 A
0010	10.0 A
0015	15.0 A
0019	18.5 A
0025	24.5 A
0032	32.0 A
0039	39.0 A
0045	45.0 A
0060	60.0 A
0075	75.0 A
0091	91.0 A

1PH 200V

Code	Output rated current
0011	11.0 A
0018	18.0 A

Code	Shipping destination
E	EU
A	Asia

Code	Power supply voltage
4	Three-phase 400V
7	Single-phase 200V

Code	Model type
A	A type

Code	Development code
2	2

Code	Applicable area
LM	Elevating machinery



In this manual, inverter types are denoted as "FRN__ _LM2A- _□." The boxes □ replace alphabetic letters depending on the shipping destination.

If you suspect the product is not working properly or if you have any questions about your product, contact your Fuji Electric representative.

PG interface card is available to the following ROM versions.

For detailed on how to check the ROM version, refer to the FRENIC-Lift LM2A series Reference Manual.

Table 1.1 PG interface card, and ROM Versions

PG interface card	ROM Versions
OPC-PR/PS/PSH	0300 or later
OPC-PG3/PMPG/P3ID	0600 or later

230V mode is available in FRN0019LM2A-4E to FRN0060LM2A-4E with ROM version 1500 or later.

For detailed on how to check the ROM version, refer to the FRENIC-Lift LM2A series Reference Manual.

1.2 Precautions for Using Inverters

When handling inverters, be sure to observe the wiring precautions given below.

- (1) The maximum wiring distance between an inverter and a motor

The maximum wiring is 20m.

When using wire longer than the specification, that may not be able to control a motor.

If longer secondary wiring is required, consult your Fuji Electric representative.

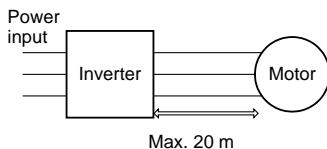

1.3 Usage environment and Storage environment

This section provides precautions when handling inverters, e.g. precautions for installation environment and storage environment.

1.3.1 Usage environment

Install the inverter in an environment that satisfies the requirements listed in Table below.

Environmental Requirements	Site location	Indoors	
	Ambient temperature	-10 to +45°C	
	Relative humidity	5 to 95% (No condensation)	
	Atmosphere	The inverter must not be exposed to dust, direct sunlight, corrosive gases, flammable gases, oil mist, vapor or water drops. Pollution degree 2 (IEC/EN 60664-1) (*1) The atmosphere can contain a small amount of salt. (0.01 mg/cm ² or less per year) The inverter must not be subjected to sudden changes in temperature that will cause condensation to occur.	
	Altitude	1,000 m max. (*2)	
	Atmospheric pressure	86 to 106 kPa	
	Vibration	3mm	: 2 to less than 9Hz
		9.8 m/s ²	: 9 to less than 20 Hz
2 m/s ²		: 20 to less than 55 Hz	
	1 m/s ²	: 55 to less than 200 Hz	

(*1) Do not install the inverter in an environment where it may be exposed to lint, cotton waste or moist dust or dirt which will clog the heat sink of the inverter. If the inverter is to be used in such an environment, install it in a dustproof panel of your system.

(*2) If you use the inverter in an altitude above 1000 m, you should apply an output current derating factor as listed in the table below.

Altitude	1000 m or lower	1000 to 1500 m	1500 to 2000 m	2000 to 2500 m	2500 to 3000 m
Output current derating factor	1.00	0.97	0.95	0.91	0.88

1.3.2 Storage environment

The storage environment in which the inverter should be stored after purchase differs from the usage environment. Store the inverter in an environment that satisfies the requirements listed below.

[1] Temporary storage

Table 1.1 Storage and Transport Environments

Item	Specifications	
Storage temperature *1	During transport: -25 to +70°C	Places not subjected to abrupt temperature changes or condensation or freezing
	During storage: -25 to +65°C	
Relative humidity	5 to 95% RH *2	
Atmosphere	The inverter must not be exposed to dust, direct sunlight, corrosive or flammable gases, oil mist, vapor, water drops or vibration. The atmosphere must contain only a low level of salt (0.01 mg/cm ² or less per year).	
Atmospheric pressure	86 to 106 kPa (during storage)	
	70 to 106 kPa (during transportation)	

*1 Assuming comparatively short time storage, e.g., during transportation or the like.

*2 Even if the humidity is within the specified requirements, avoid such places where the inverter will be subjected to sudden changes in temperature that will cause condensation or freezing.

Precautions for temporary storage

- (1) Do not leave the inverter directly on the floor.
- (2) If the environment does not satisfy the specified requirements listed in Table 1.1 wrap the inverter in an airtight vinyl sheet or the like for storage.
- (3) If the inverter is to be stored in a high-humidity environment, put a drying agent (such as silica gel) in the airtight package described in (2) above.

[2] Long-term storage

The long-term storage method of the inverter varies largely according to the environment of the storage site. General storage methods are described below.

- (1) The storage site must satisfy the requirements specified for temporary storage.
However, for storage exceeding three months, the surrounding temperature range should be within the range from -10 to +30°C. This is to prevent electrolytic capacitors in the inverter from deterioration.
- (2) The package must be airtight to protect the inverter from moisture. Add a drying agent inside the package to maintain the relative humidity inside the package within 70%.
- (3) If the inverter has been installed to the equipment or panel at construction sites where it may be subjected to humidity, dust or dirt, then temporarily remove the inverter and store it in the environment specified in Table 1.1.

Precautions for storage over 1 year

If the inverter has not been powered on for a long time, the property of the electrolytic capacitors may deteriorate. Power the inverters on once a year and keep the inverters powered on for 30 to 60 minutes. Do not connect the inverters to the load circuit (secondary side) neither run the inverter.

Chapter 2 MOUNTING AND WIRING THE INVERTER

2.1 Installing the Inverter

(1) Mounting base

Install the inverter on a base made of metal or other non-flammable material. Do not mount the inverter upside down or horizontally.

(2) Clearances

Ensure that the minimum clearances indicated in Figure 2.1 and Table 2.1 are maintained at all times. When installing the inverter in the panel of your system, take extra care with ventilation inside the panel as the ambient temperature easily rises. Do not install the inverter in a small panel with poor ventilation.

■ When mounting two or more inverters

When mounting two or more inverters in the same unit or panel, basically lay them out side by side. When mounting them one above the other, be sure to separate them with a partition plate or the like so that any heat radiating from one inverter will not affect the one(s) above.

Table 2.1 Clearances mm (inch)

Inverter capacity	A	B	C	D *1
200Vclass series : FRN0011LM2A-7□ FRN0018LM2A-7□	0	10	100	0
400Vclass series : FRN0006LM2A-4□ to FRN0032LM2A-4□	(0)	(0.39)	(3.9)	(0)
FRN0039LM2A-4□ to FRN0045LM2A-4□	10 (0.39)	10 (0.39)	100 (3.9)	0 (0)
FRN0060LM2A-4□ to FRN0091LM2A-4□	50 (1.97)	50 (1.97)	100 (3.9)	100 (3.9)

*1) D: Space required in front of the inverter unit

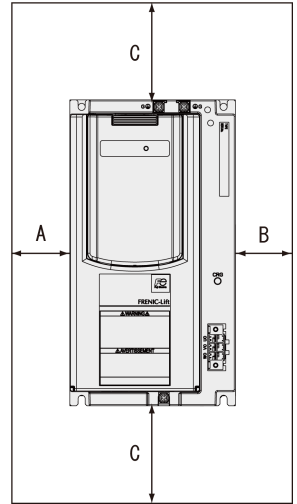

Figure 2.1 Mounting Direction and Required Clearances

2.2 Wiring

Follow the procedure below. In the following description, it is assumed that the inverter has already been installed.

2.2.1 Removing the front cover

- ① Remove the keypad blind cover and loosen the screws
- ② Hold the right and left ends of the front cover and remove it.

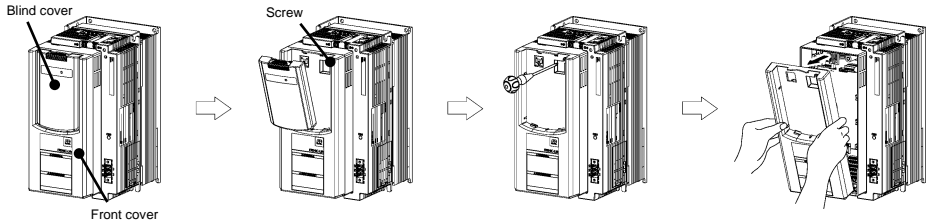

(FRN0011LM2A-7□/FRN0018LM2A-7□, FRN0006LM2A-4□ to FRN0032LM2A-4□)

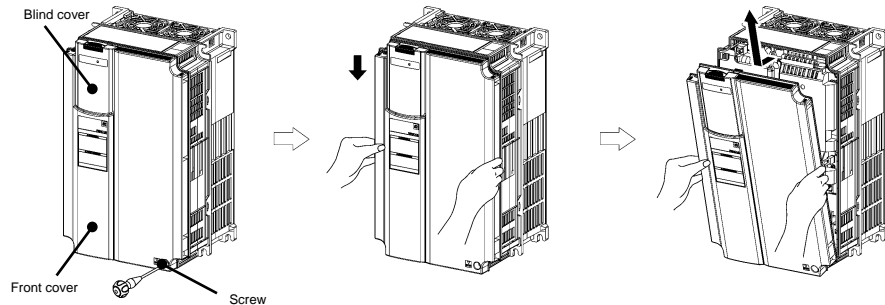

(FRN0039LM2A-4□/FRN0045LM2A-4□)

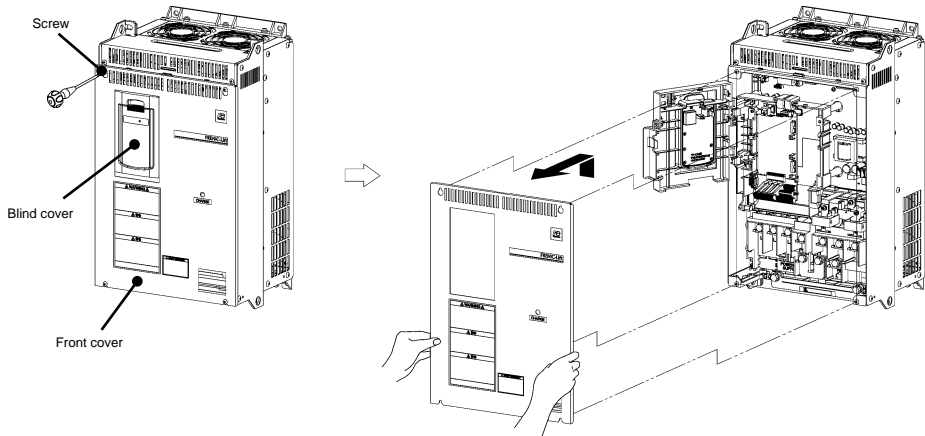

(FRN0060LM2A-4□ to FRN0091LM2A-4□)

2.2.2 Mounting the front cover

After wiring, mount the front cover back into place.

(Tightening torque: 1.8N·m)

2.2.3 Recommended wire sizes

For the recommended wire sizes for the main circuits, refer to the "Conformity to the Low Voltage Directive in the EU" given in Preface. Terminals for the main circuits should have insulation, insulation tubes, or similar treatment.

2.2.4 Terminal arrangement diagrams and screw specifications

The tables and figures given below show the screw specifications and terminal arrangement diagrams. Note that the terminal arrangements differ depending on the inverter capacity.

(1) Main circuit terminals

Table 2.2 Main Circuit Terminals (kW rating)

Power supply voltage	Nominal applied motor (kW)	Inverter type	Input/Output/ Main circuit terminals		Short circuit terminals		24VDC input terminals, Aux main power supply		Grounding terminals	
			Screw size	Tightening torque (N-m)	Screw size	Tightening torque (N-m)	Screw size	Tightening torque (N-m)	Screw size	Tightening torque (N-m)
Three-phase 400V	2.2	FRN0006LM2A-4□	M3.5	1.0	M3.5	1.0	M2.5	0.27	M4	1.8
	4.0	FRN0010LM2A-4□								
	5.5	FRN0015LM2A-4□								
	7.5	FRN0019LM2A-4□								
	11	FRN0025LM2A-4□	M4.5	1.2					M5	3.5
	15	FRN0032LM2A-4□								
	18.5	FRN0039LM2A-4□	M6	5.8	-	-			M6	5.8
	22	FRN0045LM2A-4□								
	30	FRN0060LM2A-4□	M8	13.5	-	-	M3.5	1.2	M8	13.5
37	FRN0075LM2A-4□									
45	FRN0091LM2A-4□									
Single-phase 200V	2.2	FRN0011LM2A-7□	M3.5	1.0	M3.5	1.0	M2.5	0.27	M4	1.8
	4.0	FRN0018LM2A-7□								

◆ FRN0011LM2A-7□/FRN0018LM2A-7□, FRN0006LM2A-4□ to FRN0019LM2A-4□

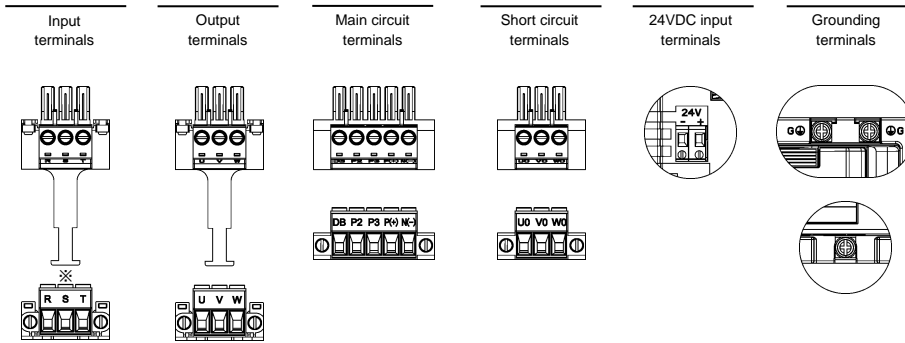
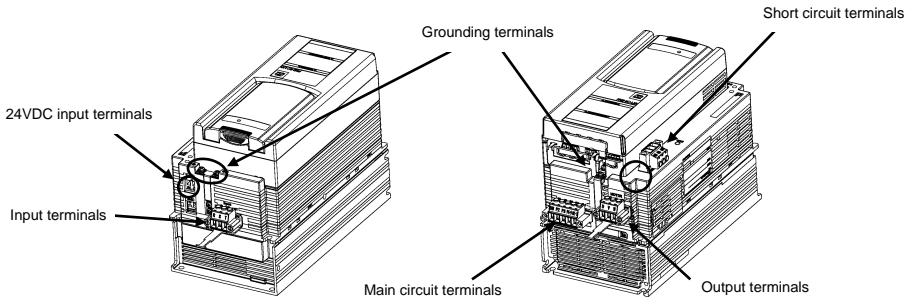

※Do not wire FRN0011LM2A-7□

◆ FRN0025LM2A-4□/FRN0032LM2A-4□

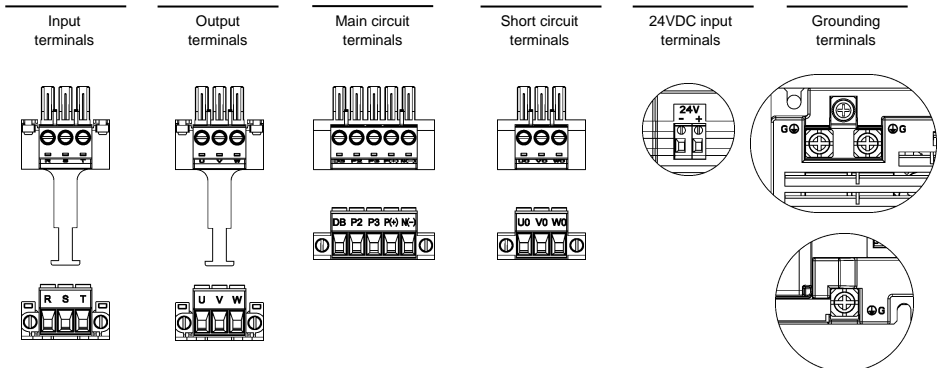
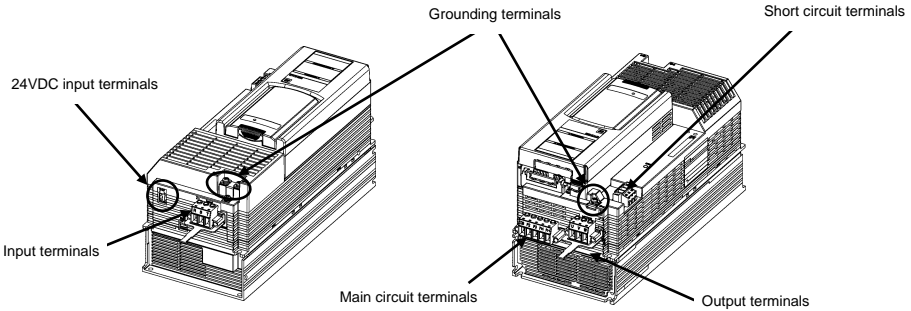

Connection method with shield plate of input and output terminals.

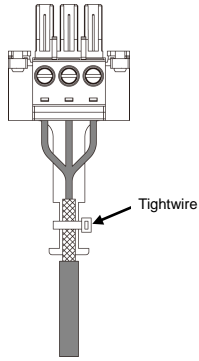

(FRN0011LM2A-7□ / FRN0018LM2A-7□, FRN0006LM2A-4□ to FRN0032LM2A-4□)

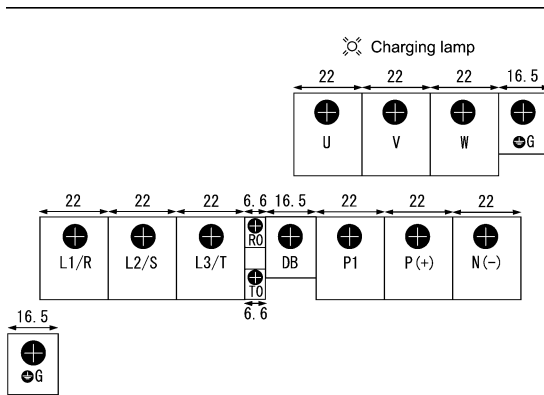

(FRN0039LM2A-4□ / FRN0045LM2A-4□)

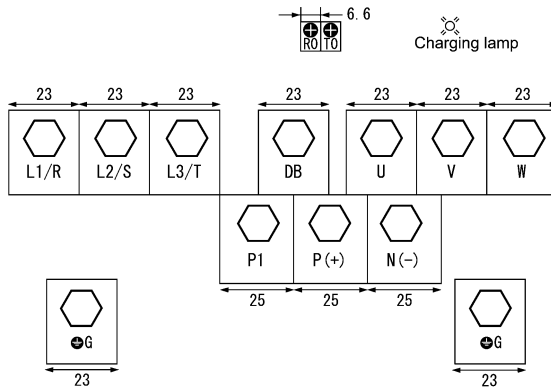

(FRN0060LM2A-4□ to FRN0091LM2A-4□)

(2) Arrangement of control circuit terminals

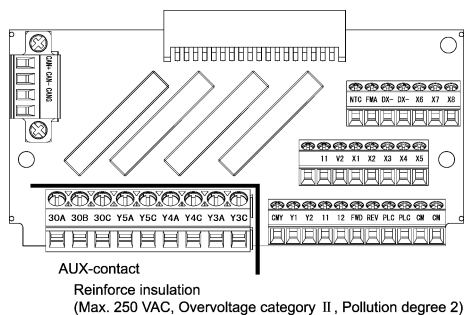
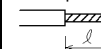
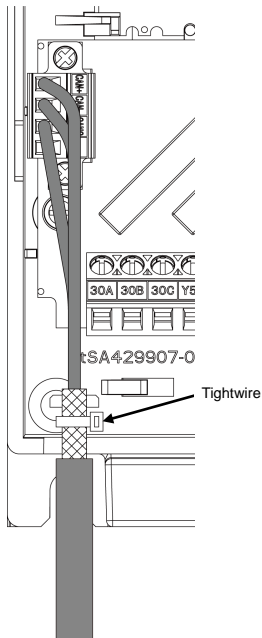

Table 2.3 Control Circuit Terminals

Terminal block type	Screw specifications		Recommended wire size (mm ²)	Type of screwdriver (tip shape)	Wire strip length 
	Screw size	Tightening torque			
Relay terminals	M2.5	0.39 ± 10% N·m	0.20 to 3.31 mm ² (AWG24 to 12)	Flat screwdriver (0.4 mm x 3.0mm)	6mm
Other	M2	0.19 ± 10% N·m	0.20 to 1.31 mm ² (AWG24 to 16)	Flat screwdriver (0.4 mm x 2.5 mm)	6 mm

Connection method with shield plate of CANopen terminal.



(FRN0011LM2A-7□/
FRN0018LM2A-7□)
(FRN0006LM2A-4□ to
FRN0032LM2A-4□)

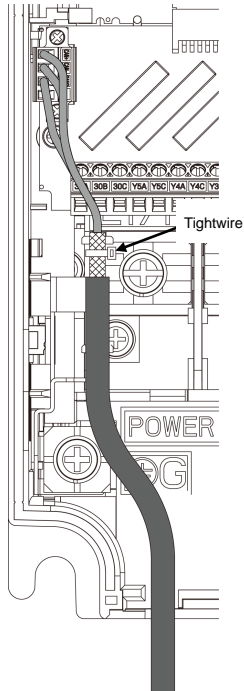

(FRN0039LM2A-4□/
FRN0045LM2A-4□)

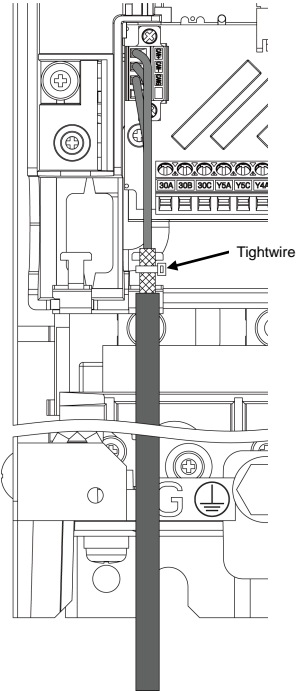





(FRN0060LM2A-4□ to
FRN0091LM2A-4□)

2.2.5 Terminal functions and wiring order

Main circuit terminals and grounding terminals

The table below shows the order of wiring and terminal functions. Carry out wiring in the order shown in Table 2.4 below.

Table 2.4 Order of Wiring and Functions of Main Circuit Terminals

Classification	Name	Symbol	Functions
Main circuit (Note)	Primary grounding terminals for inverter enclosure	 G	The two grounding terminals ( G) can be either used for the power supply wiring (primary circuit) or motor wiring (secondary circuit). Be sure to ground either of the two grounding terminals for safety and noise reduction.
	Secondary grounding terminals for motor	 G	Connect the secondary grounding wire for the motor to the grounding terminal ( G).
	Inverter output terminals	U, V, W	Connect the three wires of the 3-phase motor to terminals U, V, and W, taking care of the correct motor phase correspondence. (*3)
	Inverter output for Short circuit	U0, V0, W0	For a short circuit for PMS motor. These outputs are connected internally to U, V, W.
	Auxiliary control power input terminals *1	24V+, 24V-	Connect the power as for the 24VDC to these terminals as a control circuit power backup. In 230 V mode, use it only during rescue operation, and do not connect during normal operation.
		R0, T0	Connect the same AC power as for the main circuit to these terminals as a control circuit power backup.
	DC reactor connection terminals *2	P2, P3	Connect a DC reactor (DCR) to improve the power factor and to fulfill with EN 12015 and EN 61000-3-12 regarding harmonic distortion When not connecting DCR, short-circuit by a wire.
		P1, P(+)	
	Braking resistor connection terminals	P(+), DB	Connect a braking resistor to use the regeneration brake.
DC link bus terminals	P(+), N(-)	A DC link bus is connectable to these terminals. When you need to use the DC link bus terminals P(+) and N(-), consult your Fuji Electric representative.	
Main circuit power input terminals	L1/R, L2/S, L3/T or L1/L, L2/N	The three-phase input power lines or single-phase input power lines are connected to these terminals. If the power wires are connected to other terminals, the inverter will be damaged when the power is turned ON.	
Control circuit	Control circuit terminals	See Table 2.5.	Route the wiring of the control circuit as far from that of the main circuit as possible. Otherwise, electric noise may cause malfunctions. When the Enable function is not to be used, short-circuit terminals [EN1] and [PLC] and terminals [EN2] and [PLC] using jumper wires.

(Note) Do not connect wiring to unassigned main circuit terminals (marked with NC). For details about the terminal block, refer to Section 2.2.3 "Terminal arrangement diagrams and screw specifications."

*1) 24V+,24V-: 200 V class series inverters and 400 V ones of FRN0032 or less
R0T0 : 400 V ones of FRN0039 or above

*2) P2,P3 : 200 V class series inverters and 400 V ones of FRN0032 or less
P1,P(+): 400 V ones of FRN0039 or above

Wiring of Auxiliary control power input terminals

Auxiliary control power input terminals 24V+ and 24V-
Terminal rating: 22 to 32VDC, Maximum current 2.0A, Maximum power 40W.

Auxiliary control power input terminals R0 and T0
Terminal rating: 220 to 480Vac 50Hz/60Hz, Maximum current 1.0A, Maximum power 50W.

■ Wiring notes

To make the machinery or equipment compliant with the EMC standards, wire the motor and inverter in accordance with the following.

(*3) Use shielded wires for the motor cable and route the cable as short as possible. Firmly clamp the shield to the grounded metal plate.

 For details about wiring, refer to Chapter 8, Section 8.4 "Compliance with EMC Standards."

Control circuit terminals

Table 2.5 Names, Symbols and Functions of the Control Circuit Terminals

Classification	Name	Symbol	Functions																										
Analog input	Analog setting voltage input	[12]	External voltage input that commands the frequency externally. (1) Input voltage range : 0 to $\pm 10\text{VDC}$ / 0 to $\pm 100\%$ (2) Hardware specifications · Input impedance : 22 k Ω · The maximum input voltage is $\pm 15\text{VDC}$, however, more than $\pm 15\text{VDC}$ is regarded as $\pm 10\text{VDC}$.																										
	Analog setting voltage input Analog setting current input	[V2] (V2/C1)	External voltage input that commands the frequency externally. (1) Input voltage range : 0 to $\pm 10\text{VDC}$ / 0 to $\pm 100\%$ (2) hardware specifications · Input impedance : 22 k Ω · The maximum input voltage is $\pm 15\text{VDC}$, however, more than $\pm 15\text{VDC}$ is regarded as $\pm 10\text{VDC}$. External current input that commands the frequency externally. (1) Input voltage range : 4 to 20mADC / 0 to 100% (2) hardware specifications · Input impedance : 250 Ω · The maximum input current is 30mADC, however, more than 20mADC is regarded as 20mADC.																										
	PTC/NTC thermistor input.	[NTC] (PTC/NTC)	Connection of a PTC (Positive Temperature Coefficient) or NTC (Negative Temperature Coefficient) thermistor for motor protection.																										
	Analog common	[11]	Common terminal for analog input signals.																										
Digital input	Digital input 1 to Digital input 8	[X1] [X2] [X3] [X4] [X5] [X6] [X7] [X8]	(1) Various signals such as "Coast to a stop," "Enable external alarm trip," and "Select multi-frequency" can be assigned to terminals [X1] to [X8], [FWD] and [REV] by setting function codes E01 to E08, E98, and E99. (2) Input mode, i.e. SINK and SOURCE, is changeable by using the slide switch SW1. (3) The logic value (1/0) for ON/OFF of the terminals [X1] to [X8], [FWD], or [REV] can be switched. If the logic value for ON of the terminal [X1] is "1" in the normal logic system, then OFF is "1" in the negative logic system and vice versa.																										
	Run forward command	[FWD]																											
	Run reverse command	[REV]																											
			(Digital input circuit specifications)																										
			<table border="1"> <thead> <tr> <th colspan="2">Item</th> <th>Min.</th> <th>Max.</th> </tr> </thead> <tbody> <tr> <td rowspan="2">Operating voltage (SOURCE)</td> <td>ON level</td> <td>22 V</td> <td>27 V</td> </tr> <tr> <td>OFF level</td> <td>0 V</td> <td>2 V</td> </tr> <tr> <td rowspan="2">Operating voltage (SINK)</td> <td>ON level</td> <td>0V</td> <td>2V</td> </tr> <tr> <td>OFF level</td> <td>22V</td> <td>27V</td> </tr> <tr> <td colspan="2">Operating current at ON (Input voltage is at 27 V)</td> <td>2.5 mA</td> <td>5 mA</td> </tr> <tr> <td colspan="2">Allowable leakage current at OFF</td> <td>-</td> <td>0.5 mA</td> </tr> </tbody> </table>	Item		Min.	Max.	Operating voltage (SOURCE)	ON level	22 V	27 V	OFF level	0 V	2 V	Operating voltage (SINK)	ON level	0V	2V	OFF level	22V	27V	Operating current at ON (Input voltage is at 27 V)		2.5 mA	5 mA	Allowable leakage current at OFF		-	0.5 mA
Item		Min.	Max.																										
Operating voltage (SOURCE)	ON level	22 V	27 V																										
	OFF level	0 V	2 V																										
Operating voltage (SINK)	ON level	0V	2V																										
	OFF level	22V	27V																										
Operating current at ON (Input voltage is at 27 V)		2.5 mA	5 mA																										
Allowable leakage current at OFF		-	0.5 mA																										

Table 2.5 Names, Symbols and Functions of the Control Circuit Terminals (continued)

Classification	Name	Symbol	Functions																
Digital input	Enable input 1 Enable input 2	[EN1] [EN2]	<p>(1) Opening the circuit between terminals [EN1] and [PLC] or terminals [EN2] and [PLC] stops the operation of the inverter output transistor by STO functional safety function according to IEC/EN 61800-5-2.</p> <p>(2) The input mode of terminals [EN1] and [EN2] is fixed at the SOURCE mode. No switching to the SINK mode is possible.</p> <p>(3) If either one of [EN1] and [EN2] is OFF, an alarm occurs. (ECF alarm) This alarm state can be cleared only by turning the inverter power off and on.</p> <p><Enable input circuit specifications></p> <table border="1"> <thead> <tr> <th>Item</th> <th>Min.</th> <th>Max.</th> </tr> </thead> <tbody> <tr> <td rowspan="2">Operating voltage</td> <td>ON level</td> <td>22 V</td> <td>27 V</td> </tr> <tr> <td>OFF level</td> <td>0 V</td> <td>2 V</td> </tr> <tr> <td>Operating current at ON (Input voltage is at 27 V)</td> <td>2.5 mA</td> <td>5 mA</td> </tr> <tr> <td>Allowable leakage current at OFF</td> <td>—</td> <td>0.5 mA</td> </tr> </tbody> </table>	Item	Min.	Max.	Operating voltage	ON level	22 V	27 V	OFF level	0 V	2 V	Operating current at ON (Input voltage is at 27 V)	2.5 mA	5 mA	Allowable leakage current at OFF	—	0.5 mA
	Item	Min.	Max.																
	Operating voltage	ON level	22 V	27 V															
OFF level		0 V	2 V																
Operating current at ON (Input voltage is at 27 V)	2.5 mA	5 mA																	
Allowable leakage current at OFF	—	0.5 mA																	
PLC signal power	[PLC]	Connects to the output signal power supply of Programmable Logic Controller (PLC). Rated voltage: 24 VDC (Allowable range: +22 to +27 VDC), Maximum output current 100 mA DC																	
Digital input common	[CM]	Common terminals for digital input signals																	

Table 2.5 Names, Symbols and Functions of the Control Circuit Terminals (continued)

Classification	Name	Symbol	Functions														
Analog output	Analog monitor	[FMA]	These terminals output monitor signals for analog DC voltage (-10 to +10 V).														
	Analog common	[11]	Common terminal for analog output signals.														
Transistor output	Transistor output 1 to Transistor output 2	[Y1] [Y2]	<p>Both the SINK and SOURCE modes are supported.</p> <p>(1) Various signals such as "Inverter running," "Frequency arrival signal," and "Motor overload early warning" can be assigned to terminals [Y1] and [Y2] by setting function code E20 and E21.</p> <p>(2) The logic value (1/0) for ON/OFF of the terminals between [Y1] or [Y2] and [CMY] can be switched. If the logic value for ON between [Y1] or [Y2] and [CMY] is "1" in the normal logic system, then OFF is "1" in the negative logic system and vice versa.</p> <p>(Transistor output circuit specification)</p>  <table border="1" data-bbox="588 683 968 885"> <thead> <tr> <th colspan="2">Item</th> <th>Max.</th> </tr> </thead> <tbody> <tr> <td rowspan="2">Operating voltage</td> <td>ON level</td> <td>3 V</td> </tr> <tr> <td>OFF level</td> <td>48 V</td> </tr> <tr> <td colspan="2">Maximum current at ON</td> <td>50 mA</td> </tr> <tr> <td colspan="2">Leakage current at OFF</td> <td>0.1 mA</td> </tr> </tbody> </table>	Item		Max.	Operating voltage	ON level	3 V	OFF level	48 V	Maximum current at ON		50 mA	Leakage current at OFF		0.1 mA
		Item		Max.													
Operating voltage	ON level	3 V															
	OFF level	48 V															
Maximum current at ON		50 mA															
Leakage current at OFF		0.1 mA															
	Transistor output common	[CMY]	Common terminal for transistor output signals														

Table 2.5 Names, Symbols and Functions of the Control Circuit Terminals (continued)

Classification	Name	Symbol	Functions										
	General-purpose relay outputs	[Y3A/C] [Y4A/C] [Y5A/C]	<p>(1) Any one of output signals that can be assigned to terminals [Y1] and [Y2] can also be assigned to this relay contacts, as a general-purpose relay output, in order to use it for outputting a signal.</p> <p>(2) Whether excitation or non-excitation causes this terminal to output a signal can be switched.</p> <p>(3) Contact capacity and the life are shown by table below.</p> <table border="1"> <thead> <tr> <th>Contact capacity</th> <th>Average of life (cycle)</th> </tr> </thead> <tbody> <tr> <td>250VAC,0.5A,cosϕ=0.3</td> <td>300,000</td> </tr> <tr> <td>250VAC,1A,cosϕ=0.3</td> <td>150,000</td> </tr> <tr> <td>30VDC,0.5A</td> <td>300,000</td> </tr> <tr> <td>30VDC,1A</td> <td>150,000</td> </tr> </tbody> </table>	Contact capacity	Average of life (cycle)	250VAC,0.5A,cos ϕ =0.3	300,000	250VAC,1A,cos ϕ =0.3	150,000	30VDC,0.5A	300,000	30VDC,1A	150,000
Contact capacity	Average of life (cycle)												
250VAC,0.5A,cos ϕ =0.3	300,000												
250VAC,1A,cos ϕ =0.3	150,000												
30VDC,0.5A	300,000												
30VDC,1A	150,000												
Relay output	Alarm relay output (for any error)	[30A/B/C]	<p>(1) When the protective function is activated, this terminal outputs a contact signal (1C) to stop the motor.</p> <p>(2) Any one of output signals that can be assigned to terminals [Y1] and [Y2] can also be assigned to this relay contact as a general-purpose relay output, in order to use it for outputting a signal.</p> <p>(3) Whether excitation or non-excitation causes this terminal to output a signal can be switched.</p> <p>(4) Contact capacity and the life are shown by table below.</p> <table border="1"> <thead> <tr> <th>Contact capacity</th> <th>Average of life (cycle)</th> </tr> </thead> <tbody> <tr> <td>250VAC,0.5A,cosϕ=0.3</td> <td>100,000</td> </tr> <tr> <td>250VAC,1A,cosϕ=0.3</td> <td>50,000</td> </tr> <tr> <td>30VDC,0.5A</td> <td>100,000</td> </tr> <tr> <td>30VDC,1A</td> <td>50,000</td> </tr> </tbody> </table>	Contact capacity	Average of life (cycle)	250VAC,0.5A,cos ϕ =0.3	100,000	250VAC,1A,cos ϕ =0.3	50,000	30VDC,0.5A	100,000	30VDC,1A	50,000
Contact capacity	Average of life (cycle)												
250VAC,0.5A,cos ϕ =0.3	100,000												
250VAC,1A,cos ϕ =0.3	50,000												
30VDC,0.5A	100,000												
30VDC,1A	50,000												
Communication	RS-485 communications port 2 (On the terminal block)	[DX+]/ [DX-]	These I/O terminals are used as a communications port that transmits data through the RS-485 multipoint protocol between the inverter and a computer or other equipment such as a PLC or elevator controller.										
	RS-485 communications port 1 (For connection of the keypad)	RJ-45 connector	Used to connect the keypad to the inverter. The inverter supplies the power to the keypad via the extension cable for remote operation.										
	CAN open communications	[CAN+] [CAN-] [CANG]	These I/O terminals are used as a communications port that transmits data through the CANopen multipoint protocol between the inverter and a computer or other equipment such as a PLC or elevator controller.										

2.2.6 Connection diagrams

This section shows connection diagrams with the Enable input function used.

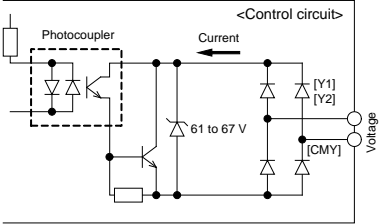

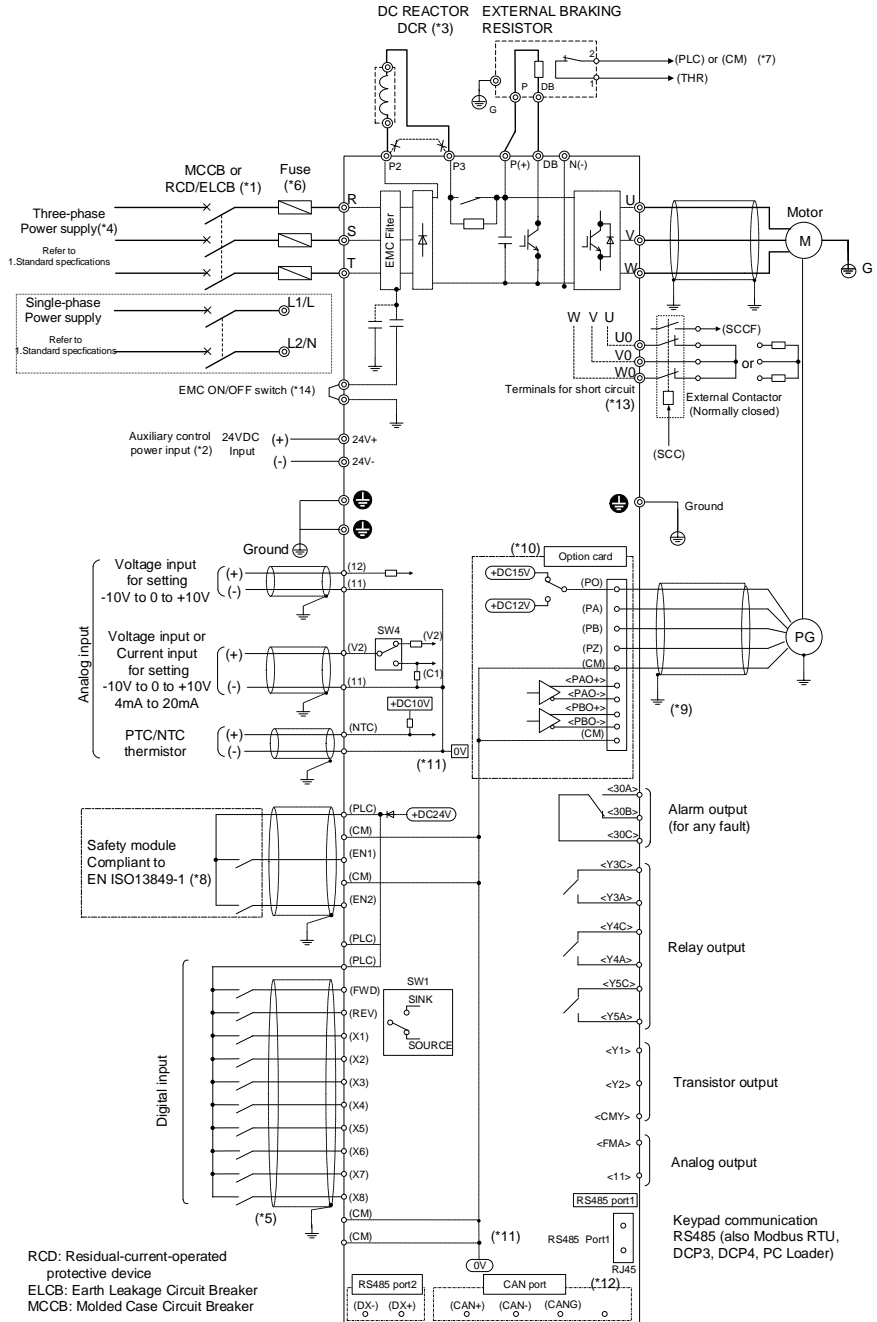
FRN0011LM2A-7□/ FRN0018LM2A-7□, FRN0006LM2A-4□ to FRN0032LM2A-4□

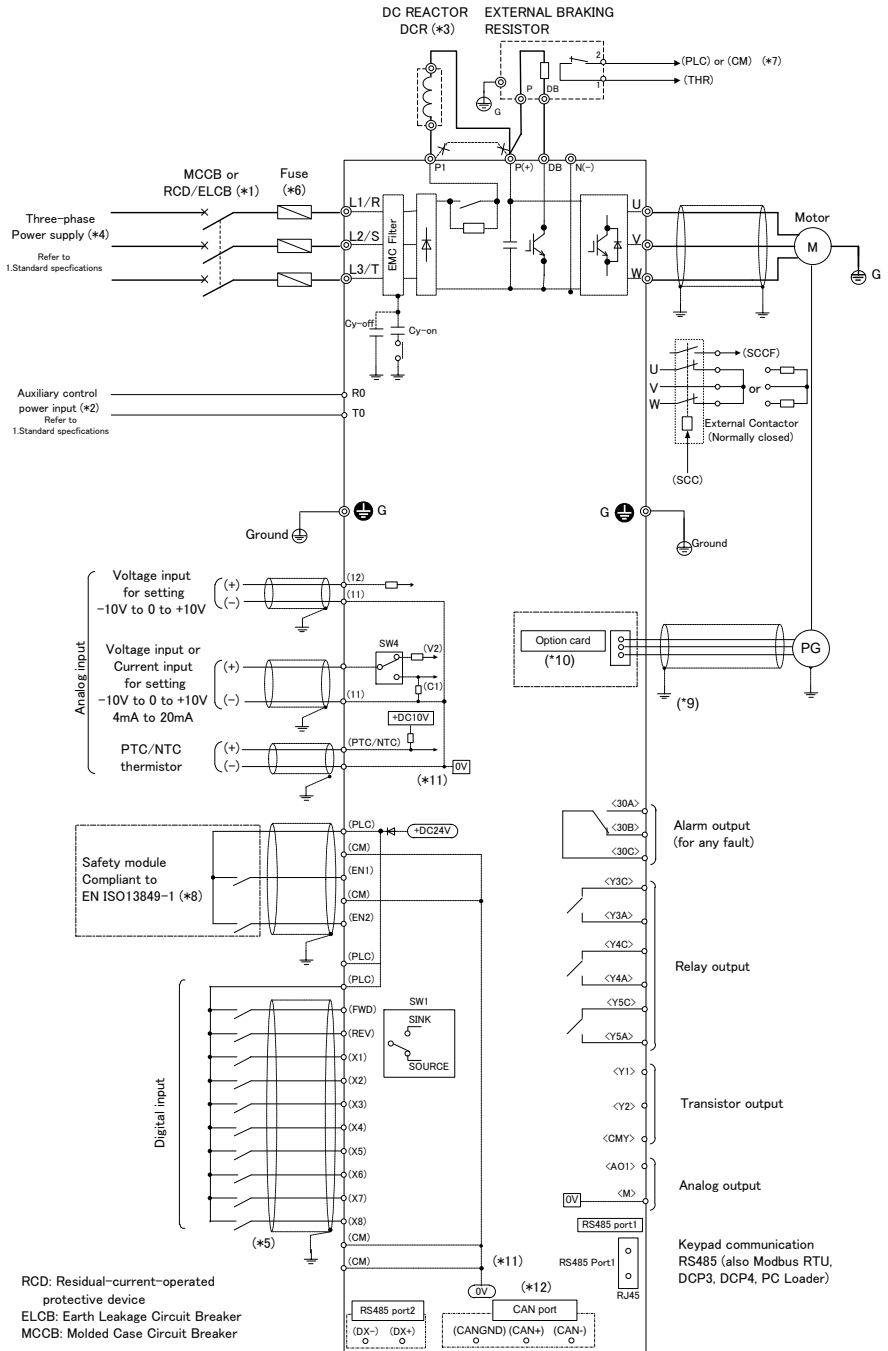

- (*1) Install a recommended molded case circuit breaker (MCCB) or residual-current-operated protective device (RCD)/earth leakage circuit breaker (ELCB) (with over current protection function) in the primary circuit of the inverter to protect wiring.
- (*2) Refer to table 2.4. In 230 V mode, use it only during rescue operation, and do not connect during normal operation.
- (*3) Mount a jumper cable between terminals P2 and P3 when a DCR is not used. The direct current reactor (DCR) is a separately installed option.
- (*4) Use the inverter connecting the power system which has earthed neutral-point. In case of non-earthed system (ex. I-T NET), the control interface of the inverter becomes basic insulation, thus do not connect SELV circuit from external controller directly.
- (*5) For the control signal wires, use shielded or twisted wires. Ground shielded wires. To prevent malfunction due to noise, keep the control circuit wiring away from the main circuit wiring as far as possible (recommended: 10 cm or more), and never lay them in the same wire duct. When crossing the control circuit wiring with the main circuit wiring, lay them at right angles.
- (*6) To bring the inverter into compliance with the European electrical safety standard IEC/EN 61800-5-1 or compliance with Canadian and U.S. standards (CSA certification), be sure to insert the specified fuse (see Instruction Manual) in the primary circuit of the inverter.
- (*7) Connection terminal depends on SOURCE/SINK setting by slide switch SW1 (please refer to chapter 2.2.7). Connect to (PLC) terminal when SOURCE is set, and to (CM) terminal when SINK is set.
- (*8) When the Enable inputs (EN1, EN2) function is not to be used, keep terminals [EN1]-[PLC] and [EN2]-[PLC] short circuited using jumper wires. For opening and closing the hardware circuit between terminals [EN1] and [PLC] and between [EN2] and [PLC], use safe relay device approved according to EN ISO 13849-1 PL-e, IEC/EN 61800-5-2 SIL3 or EN 81-20.
- (*9) Wiring must use shielded lines. Please connect the shield appropriately according to the specification of the encoder and the connection with the controller. In the above figure, the shield is connected with the earth line of the inverter side and not connected on the motor. It is likely to be improved by connecting the inverter side with (CM) when malfunction occurs due to noise etc. When the wiring between the encoder and the inverter is long, the allophone and the torque ripple might be generated because the signal from the encoder malfunctions by interfering with A phase and B phase. In this case, please execute measures such as; wiring shorter cable, cable of smaller stray capacitance, etc.
- (*10) The encoder interface is provided by an option card.
- (*11) 0V and 0V are separated and insulated.
- (*12) CAN signals are isolated from other internal circuit.
- (*13) U0,V0,W0 are connected with U,V,W respectively.
- (*14) The EMC filter can be enabled/disabled. If the EMC terminal is connected, EMC filter is enabled (this is default setting). If the EMC terminal is disconnected, the EMC filter is disabled.



RCD: Residual-current-operated protective device
ELCB: Earth Leakage Circuit Breaker
MCCB: Molded Case Circuit Breaker

- (*1) Install a recommended molded case circuit breaker (MCCB) or residual-current-operated protective device (RCD)/earth leakage circuit breaker (ELCB) (with over current protection function) in the primary circuit of the inverter to protect wiring.
- (*2) Even if this terminal is not connected, the inverter can be operated with connection of the main circuit (L1/R, L2/S, L3/T).
Please wire for this terminal to operate the control circuit of the inverter when there is no power supply.
- (*3) When connecting an optional DC reactor (DCR), remove the jumper bar from the terminals P1 and P(+). The direct current reactor (DCR) is a separately installed option. DCR must be connected when using FRN0060LM2A-4E in 230V mode.
- (*4) Use the inverter connecting the power system which has earthed neutral-point. In case of non-earthed system (ex. I-T NET), the control interface of the inverter becomes basic insulation, thus do not connect SELV circuit from external controller directly.
- (*5) For the control signal wires, use shielded or twisted wires. Ground shielded wires. To prevent malfunction due to noise, keep the control circuit wiring away from the main circuit wiring as far as possible (recommended: 10cm or more), and never lay them in the same wire duct. When crossing the control circuit wiring with the main circuit wiring, lay them at right angles.
- (*6) To bring the inverter into compliance with the European electrical safety standard IEC/EN 61800-5-1 or compliance with Canadian and U.S. standards (CSA certification), be sure to insert the specified fuse (see Instruction Manual) in the primary circuit of the inverter.
- (*7) Connection terminal depends on SOURCE/SINK setting by slide switch SW1. Connect to (PLC) terminal when SOURCE is set, and to (CM) terminal when SINK is set.
- (*8) When the Enable inputs (EN1, EN2) function is not to be used, keep terminals [EN1]-[PLC] and [EN2]-[PLC] short circuited using jumper wires. For opening and closing the hardware circuit between terminals [EN1] and [PLC] and between [EN2] and [PLC], use safe relay device approved according to EN ISO 13849-1 PL-e, IEC/EN 61800-5-2 SIL3 or EN 81-20.
- (*9) Wiring must use shielded lines. Please connect the shield appropriately according to the specification of the encoder and the connection with the controller. In the above figure, the shield is connected with the earth line of the inverter side and not connected on the motor. It is likely to be improved by connecting the inverter side with (CM) when malfunction occurs due to noise etc. When the wiring between the encoder and the inverter is long, the allophone and the torque ripple might be generated because the signal from the encoder malfunctions by interfering with A phase and B phase. In this case, please execute measures such as; wiring shorter cable, cable of smaller stray capacitance, etc.
- (*10) The encoder interface is provided by an option card.
- (*11)  and  are separated and insulated.
- (*12) CAN signals are isolated from other internal circuit.

2.2.7 Setting the slide switches on the control PCB

Switching the slide switches located on the control PCB (see Figure 2.4) allows you to customize the operation mode of the analog output terminals, digital I/O terminals, and communications ports.

To access the slide switches, remove the front cover so that you can see the control PCB.

 For details on how to remove the front cover, refer to Section 2.2.1.

Table 2.6 lists function of each slide switch.

Table 2.6 Function of Slide Switches

Switch	Function
SW1	Switches the service mode of the digital input terminals between SINK and SOURCE.
SW2	Switches the terminating resistor of RS-485 communications port 1 on the inverter ON and OFF. (RS-485 communications port 1 for connecting the keypad)
SW3	Switches the terminating resistor of RS-485 communications port 2 on the inverter ON and OFF. (RS-485 communications. port 2 on the terminal block)
SW4	Switches the function of terminal [V2/C1] between V2 and C1.
SW5	Switches the terminating resistor of CANopen communications port on the inverter ON and OFF (CANopen communications port on the terminal block).

Figure 2.4 shows the location of slide switches on the control PCB.

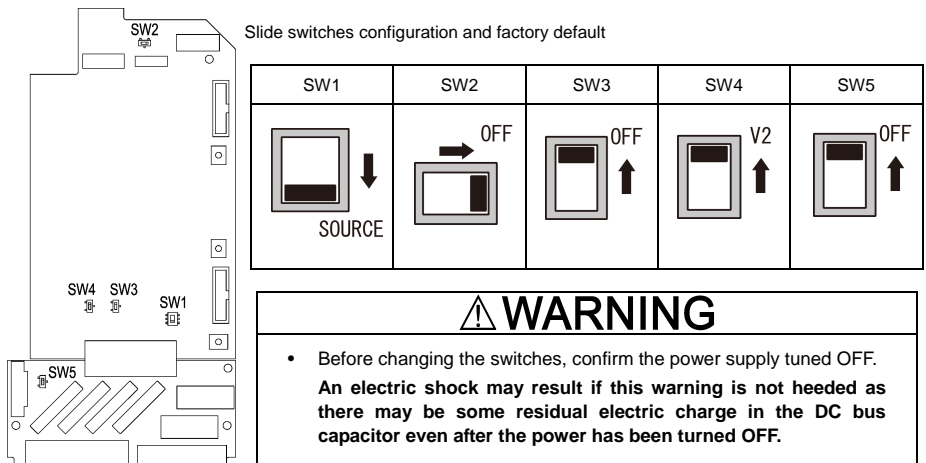
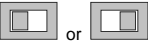



Figure 2.4 Location of the Slide Switches on the Control PCB



Note To change the setting of a slide switch, use a tool with a narrow tip (e.g., a tip of tweezers). Be careful not to touch other electronic parts, etc. If the slide switch is in an intermediate position, it is unclear whether the circuit is turned ON or OFF, and the digital input remains in an undefined state. Be sure to place the slide switch so that it contacts either side of the switch.

Slide switch in the correct position	 or 
Slide switch in an ambiguous position	

2.2.8 Mounting and connecting the keypad to the panel

You can remove the keypad cover from the inverter unit and to mount keypad (option) on the panel or install it at a remote site. (e.g., for operation on hand).

 For detailed instructions on how to mount the keypad on the panel, refer to the TP-A1-LM2 installation manual.

Chapter 3 OPERATION USING THE KEYPAD

The FRENIC-Lift has no standard keypad. Using the optional multi-function keypad allows you to start and stop the motor, monitor running status, and switch to the menu mode. You may also set the function code data, monitor I/O signal states, maintenance information, and alarm information.

For details of the multi-function keypad, refer to the FRENIC-Lift LM2A series Reference Manual.

Chapter 4 RUNNING THE MOTOR FOR A TEST

4.1 Checking Prior to Powering ON

Check the following before powering on the inverter.

(1) Check that the wiring is correct.

Especially check the wiring to the inverter input terminals L1/R, L2/S and L3/T and output terminals U, V, and W. Also check that the grounding wires are connected to the grounding terminals (⊕G) correctly. See Figure 4.1.

(2) Check the control circuit terminals and main circuit terminals for short circuits or ground faults.

(3) Check for loose terminals, connectors and screws.

(4) Check that the motor is separated from mechanical equipment.

(5) Make sure that all switches of devices connected to the inverter are turned OFF. Powering on the inverter with any of those switches being ON may cause an unexpected motor operation.

(6) Check that safety measures are taken against runaway of the equipment, e.g., a defense to prevent people from access to the equipment.

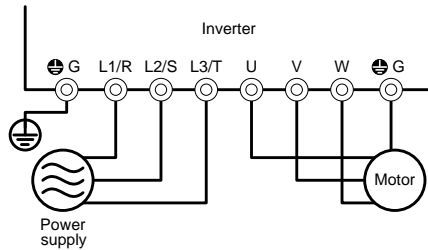

Figure 4.1 Connection of Main Circuit Terminals

4.2 Powering ON and Checking

Turn the power ON and check the following points. The following assumes that no function code data is changed from the factory default.

(1) Check that the charge lamp lights up.

4.3 Configuring the Function Code Data Before Test Run

Configure the function codes listed below according to the motor ratings and your machinery design values. For the motor ratings, check the ratings printed on the motor's nameplate. For your machinery design values, ask system designers about them.



 To set up function code, you need to use the keypad (option) or to access their data via communications link. For details, refer to the FRENIC-Lift LM2A series Reference Manual.

Table 4.1 Configuring Function Code Data

Function code	Name	Function code data	Factory defaults
F04	Base Speed	Motor ratings (printed on the nameplate of the motor)	1500 (r/min)
F05	Rated Voltage at Base Speed		190 (V) / 380 (V)
P01*	Motor (No. of poles)		4 (P)
P02	Motor (Rated capacity)		Nominal applied motor capacity.
P03	Motor (Rated current)		Rated current of nominal applied motor.
P06	Motor (No-load current)		No load current of the standard motor.
P07	Motor (%R1)		Primary resistance of the standard motor.
P08	Motor (%X)		Leakage reactance of the standard motor.
P12	Motor (Rated slip)		0.00 (Hz) ⁻¹ *1 The rated slip of the standard motor is applied.
L01	Pulse Encoder (Selection)	Depending on data sheet of the pulse encoder.	0 : 12V/15V complementary, open collector output circuit or 5V line driver.
L02	Pulse Encoder (Resolution)		1024 (pulse / rev)
L04	Magnetic pole position Offset (Offset angle)		0.00 (deg)
F03*	Rated Speed	Machinery design values.	1450 (r/min)
F42	Motor Control Mode Selection 1		0 : Vector control with PG (Asynchronous motor)
C21*	Speed Command Unit		0 : r/min (Speed data format)
L31*	Elevator Parameter (Speed)		1000 (mm/s)
H190	Motor rotate direction		1 : Motor rotates in CW(Clockwise) direction

* Recommend to start the setting by the following order C21, P01, F03 and L31, etc.

 **Note** • In any of the following cases, motor auto-tuning (P04) is necessary because the standard settings of motor parameters for Fuji motors are not applicable:

- The motor to be driven is not a Fuji product or is a non-standard product.
- The cabling between the motor and the inverter is long.
- A reactor is inserted between the motor and inverter.
- To drive a synchronous motor, you need to tune the inverter for the offset angle of magnet pole before running the motor. (L03)
- To drive a motor with encoder, an option card should be used which has to be ordered separately.







 For details of motor tuning procedure refer to the FRENIC-Lift LM2A series Reference Manual.

4.4 Running the Inverter for Motor Operation Check

After preparations of 4.1-4.3 have been completed, begin to perform the test drive of the motor.



Note Turn on both terminals [EN1] and [EN2] before running the motor.
If terminals [EN1] or [EN2] and [PLC] are not connected, the motor doesn't rotate.



----- Test Run Procedure using the multi-function keypad (option) -----

- (1) Turn the power ON and check that the LCD monitor blink while indicating a reference speed of 0.00.
- (2) Enter the local mode by holding down the  key for at least 2 seconds. Pressing this key toggles between Local mode and Remote mode.
- (3) Select a low reference speed (safety speed) by using the  Key. Be sure of that the reference speed blinks on the LCD monitor.
- (4) Press the  key to start running the motor in the forward direction. Check that the reference speed is displayed on the LCD monitor correctly. Also check whether the motor rotating direction is correct.
- (5) To stop the motor, press the  key.
- (6) Press the  key to start running the motor in the reverse direction. Check that the reference speed is displayed on the LCD monitor correctly. Also check whether the motor rotating direction is correct.
- (7) To stop the motor, press the  key.

Note When turning the power OFF and ON again, the inverter returns to Remote mode.

< Check the following points >

- Pressing the  key runs the motor forward.
- Pressing the  key runs the motor reverse.
- Check for smooth rotation without motor humming or excessive vibration.
- Check for smooth acceleration and deceleration.

When no abnormality is found, press the  or  key again to start driving the motor and increase the motor speed using  keys. Check the above points again.

4.5 Preparation for Practical Operation

After confirming correct operation by performing a test run, make mechanical connections (connections of the machine system) and electrical connections (wiring and cabling), and set the necessary parameters properly before starting normal machine operation .

Note Before to proceed running the inverter in normal operation check the related function code data again and reconfigure it if needed.

Chapter 5 TROUBLESHOOTING

5.1 Alarm Codes

Table 5.1 Quick List of Alarm Codes

Code	Name	Description
OC1 OC2 OC3	Instantaneous overcurrent	The inverter momentary output current exceeded the overcurrent level. OC1: Overcurrent during acceleration OC2: Overcurrent during deceleration OC3: Overcurrent during running at a constant speed
EF	Ground fault	Zero-phase current caused by ground fault in the output circuit has exceeded the allowable limit. (30kW or above)
OV1 OV2 OV3	Overvoltage	The DC link bus voltage exceeded the overvoltage detection level. OV1: Overvoltage during acceleration OV2: Overvoltage during deceleration OV3: Overvoltage during running at a constant speed
LV	Undervoltage	The DC link bus voltage dropped below the undervoltage detection level.
Lin*	Input phase loss	An input phase loss occurred or the Interphase voltage unbalance rate was large.
OPL*	Output phase loss	An output phase loss occurred.
OH1	Heat sink overheat	The temperature around the heat sink has risen abnormally.
OH2	External alarm	The external alarm THR was entered. (when the THR "Enable external alarm trip" has been assigned to any digital input terminal)
OH3	Inverter internal overheat	The temperature inside the inverter has exceeded the allowable limit.
OH4	Motor protection (PTC/NTC thermistor)	The temperature of the motor has risen abnormally.
OH6	Charging resistor overheat	The temperature of the charging resistor inside the inverter has exceeded the allowable limit.
DBH	Braking register overheat	The temperature of the Braking resistor has exceeded the allowable limit.
OL1	Overload of motor 1	The electronic thermal protection for motor overload detection was activated. The internal electronic motor overload protection does not have thermal memory retention.
OLU	Inverter overload	The temperature inside the IGBT has risen abnormally.
DBA*	Braking transistor broken	Detection of an abnormality in the brake transistor
Er1	Memory error	An error has occurred when writing data to the inverter memory.
Er2	Keypad communications error	A communications error has occurred between the keypad and the inverter.
Er3	CPU error	A CPU error or LSI error has occurred.
Er4	Option communications error	A communications error has occurred between the connected option card and the inverter.
Er5	Option error	An error was detected by the connected option card (not by the inverter).
Er6	Operation protection	An incorrect operation was attempted.
Er7	Tuning error	Auto-tuning or Magnetic Pole Position Offset tuning has failed, resulting in abnormal tuning results.
Er8 ErP	RS-485 communications error (Er8: RS-485 port 1, ErP: port 2)	A communications error has occurred during RS-485 communication.
ErF	Data saving error during undervoltage	When the undervoltage protection was activated, the inverter failed to save data, showing this error.
ErH	Hardware error	The LSI on the power printed circuit board has malfunctioned due to noise, etc.

Table 5.1 Quick List of Alarm Codes (Continued)

Code	Name	Description
PG	Broken wiring in the PG	The inverter detects a broken wiring connection in the pulse encoder.
Ert	CANopen communication error	A communications error has occurred during CANopen communication.
OS	Over speed prevention	The motor speed is higher than maximum speed * L32.
ErE	Speed mismatching	The reference speed and the detection speed are different.
Ot	Over torque current	Reference torque current became excessive.
bbE	Brake confirmation	The inverter detects mismatch between the brake control signal and brake detection (feedback) signal.
tCA	Reaching maximum numbers of trip counter	The number of trip direction changes has reached the preset level.
SCA	Short-circuit control error	The inverter detects mismatch between the short-circuit control signal and short-circuit detection (feedback) signal.
LCO	Load-cell overload	Load-cell function has detected overload situation by means of preset level.
rbA	Rescue by brake alarm	No movement detected during rescue operation by brake control.
nrb	NTC wire break error	Detected a wire break in the NTC thermistor detection circuit.
ECL	Customizable logic error	A customizable logic configuration error has caused an alarm.
Eo	EN1, EN2 terminals chattering	Detected collision between ENOFF output and EN1/EN2 input terminals.
ECF	EN1, EN2 terminals circuit error	An abnormality was diagnosed in EN1, EN2 terminals circuit.

* These alarms can change enable/disable by a function code.

 For detail of function code refer to the FRENIC-Lift LM2A series Reference Manual.

Chapter 6 MAINTENANCE AND INSPECTION

Perform daily and periodic inspections to avoid trouble and keep reliable operation of the inverter for a long time.

6.1 Daily Inspection

Visually inspect the inverter for operation errors from the outside without removing the covers when the inverter is ON or operating.

- Check that the expected performance (satisfying the standard specifications) is obtained.
- Check that the surrounding environment satisfies the environmental requirements given in Chapter 7, Section 7.1 "Standard Model."
- Check that the keypad displays normally.
- Check for abnormal noise, odor, or excessive vibration.
- Check for traces of overheat, discoloration and other defects.

6.2 Periodic Inspection

Before starting periodic inspections, be sure to stop the motor, shut down the power, and wait at least 10 minutes. Make sure that the charging lamp is turned OFF. Further, make sure, using a multimeter or a similar instrument, that the DC link bus voltage between the main circuit terminals P(+) and N(-) has dropped to the safe level (+25 VDC or below).

Table 6.1 List of Periodic Inspections

Check part	Check item	How to inspect	Evaluation criteria	
Environment	<ol style="list-style-type: none"> 1) Check the ambient temperature, humidity, vibration and atmosphere (dust, gas, oil mist, or water drops). 2) Check that tools or other foreign materials or dangerous objects are not left around the equipment. 	<ol style="list-style-type: none"> 1) Check visually or measure using apparatus. 2) Visual inspection 	<ol style="list-style-type: none"> 1) The standard specifications must be satisfied. 2) No foreign or dangerous objects are left. 	
Input voltage	Check that the input voltages of the main and control circuit are correct.	Measure the input voltages using a multimeter or the like.	The standard specifications must be satisfied.	
Keypad	<ol style="list-style-type: none"> 1) Check that the display is clear. 2) Check that there is no missing part in the displayed characters. 	<ol style="list-style-type: none"> 1), 2) Visual inspection 	<ol style="list-style-type: none"> 1), 2) The display can be read and there is no fault. 	
Structure such as frame and cover	Check for: <ol style="list-style-type: none"> 1) Abnormal noise or excessive vibration 2) Loose bolts (at clamp sections). 3) Deformation and breakage 4) Discoloration caused by overheat 5) Contamination and accumulation of dust or dirt 	<ol style="list-style-type: none"> 1) Visual or auditory inspection 2) Retighten. 3), 4), 5) Visual inspection 	<ol style="list-style-type: none"> 1), 2), 3), 4), 5) No abnormalities 	
Main circuit	Common	<ol style="list-style-type: none"> 1) Check that bolts and screws are tight and not missing. 2) Check the devices and insulators for deformation, cracks, breakage and discoloration caused by overheat or deterioration. 3) Check for contamination or accumulation of dust or dirt. 	<ol style="list-style-type: none"> 1) Retighten. 2), 3) Visual inspection 	<ol style="list-style-type: none"> 1), 2), 3) No abnormalities
	Conductors and wires	<ol style="list-style-type: none"> 1) Check conductors for discoloration and distortion caused by overheat. 2) Check the sheath of the wires for cracks and discoloration. 	<ol style="list-style-type: none"> 1), 2) Visual inspection 	<ol style="list-style-type: none"> 1), 2) No abnormalities
	Terminal blocks	Check that the terminal blocks are not damaged.	Visual inspection	No abnormalities

Table 6.1 List of Periodic Inspections (Continued)

Check part	Check item	How to inspect	Evaluation criteria
Main circuit	DC link bus capacitor	1), 2) Visual inspection 3) Measure the discharge time with capacitance probe.	1), 2) No abnormalities 3) The discharge time should not be shorter than the one specified by the replacement manual.
	Transformer and reactor	Check for abnormal roaring noise and odor.	Auditory, visual, and olfactory inspection No abnormalities
	Magnetic contactor and relay	1) Check for chatters during operation. 2) Check that contact surface is not rough.	1) Auditory inspection 2) Visual inspection 1), 2) No abnormalities
Control circuit	Printed circuit board	1) Retighten. 2) Olfactory and visual inspection 3), 4) Visual inspection	1), 2), 3), 4) No abnormalities
Cooling system	Cooling fan	1) Auditory and visual inspection, or turn manually (be sure to turn the power OFF). 2) Retighten. 3) Visual inspection	1) Smooth rotation 2), 3) No abnormalities
	Ventilation path	Check the heat sink, intake and exhaust ports for clogging and foreign materials.	Visual inspection No abnormalities

Remove dust accumulating on the inverter with a vacuum cleaner. If the inverter is stained, wipe it off with a chemically neutral cloth.

6.3 List of Periodic Replacement Parts

The inverter consists of many electronic parts including semiconductor devices. Table 6.2 lists replacement parts that should be periodically replaced for preventive maintenance (use the lifetime judgment function as a guide). These parts are likely to deteriorate with age due to their construction and properties, leading to the decreased performance or failure of the inverter.

When the replacement is necessary, consult your Fuji Electric representative.

Table 6.2 Replacement Parts

Part name	Standard replacement intervals (See Notes below.)
	400V/200V class series
DC link bus capacitor	7 years
Electrolytic capacitors on printed circuit boards	7 years
Cooling fans	7 years
Relay output of control circuit terminals	Refer to Table 2.5.

- (Notes) • These replacement intervals are based on the inverter's service life estimated at an ambient temperature of 40 °C, and with a load factor of 80%. Replacement intervals may be shorter when the ambient temperature exceeds 40 °C, or when the inverter is used in an excessively dusty environment.
- Standard replacement intervals mentioned above are only a guide for replacement, and not a guaranteed service life.

6.4 Inquiries about Product and Guarantee

6.4.1 When making an inquiry

Upon breakage of the product, uncertainties, failure or inquiries, inform your Fuji Electric representative of the following information.

- 1) Inverter type (Refer to Chapter 1, Section 1.1.)
- 2) SER No. (serial number of the product) (Refer to Chapter 1, Section 1.1.)
- 3) Function codes and their data that you changed (Refer to the FRENIC-Lift LM2A series Reference Manual)
- 4) ROM version (Refer to FRENIC-Lift LM2A series Reference Manual)
- 5) Date of purchase
- 6) Inquiries (for example, point and extent of breakage, uncertainties, failure phenomena and other circumstances)

Chapter 7 SPECIFICATIONS

7.1 Standard Model

1) Three-phase 400V series

Item		Specifications							
Type FRN LM2A-4□		0006	0010	0015	0019	0025	0032		
Nominal applied motor [kW]		2.2	4.0	5.5	7.5	11	15		
Output ratings	Rated capacity ⁻¹ [kVA]	4.6	7.6	11	14	18	24		
	Rated voltage ⁻² [V]	Three-phase 380V-480V, 50/60Hz							
	Rated current ⁻³ [A]	6.1	10.0	15.0	18.5	24.5	32.0		
	Overload capacity [A] (Permissible overload time)	11.0 (3s)	18.0 (3s)	27.0 (3s)	37.0 (3s)	49.0 (3s)	64.0 (3s)		
Rated frequency [Hz]		50, 60Hz							
Input ratings	Main power supply	Normal operation	Phases, Voltage, Frequency	Three-phase, 380 to 480V, 50/60Hz					
			Variations	Voltage: +10 to -15% (Voltage unbalance: 2% or less ⁻⁴) Frequency: +5 to -5%					
		Rated current ⁻⁵ [A]	with DCR	4.5	7.5	10.6	14.4	21.1	28.8
			without DCR	8.2	13	17.3	23.2	33.0	43.8
	Required power supply capacity (with DCR) [kVA]		3.2	5.2	7.4	10	15	20	
	UPS operation	Phases, Voltage, Frequency	Single-phase, 220 to 480V, 50/60Hz						
		Variations	Voltage: +10 to -10%, Frequency: +5 to -5%						
	Operation time [s] ⁻¹⁴		180						
	Battery operation	Power Supply Voltage for driving	DC 48V or more in the direct current voltage conversion.						
		Operation time [s] ⁻¹⁴	180						
Auxiliary control power supply Voltage		DC 24V (22V to 32V), Maximum 40W							
Braking	Braking time ⁻⁷ [s]		60						
	Braking duty-cycle (%ED) ⁻⁷ [%]		50						
	Rated regenerative power ⁻⁷ [kW]		1.8	3.2	4.4	6.0	8.8	12	
	Minimum resistance which can be connected [Ω] ⁻⁶		160	96	47	47	24	24	
EMC filter		Built-in (According to EN12015, EN12016)							
Enclosure (IEC60529)		IP20							
		Heat sink IP54							
Cooling method		Fan cooling							
Average sound pressure level at trip [dBA] ⁻⁸		44.5		48		49.5			
Average power losses [W]		in standstill ⁻¹²		23		26			
		in standby ⁻¹³		16					
Weight/Mass [kg]		4.4	4.4	4.7	4.7	6.1	6.3		

Item		Specifications						
Type FRN LM2A-4□		0039	0045	0060	0075	0091		
Nominal applied motor [kW]		18.5	22	30	37	45		
Output ratings	Rated capacity ^{*1} [kVA]	29	34	45	57	69		
	Rated voltage ^{*2} [V]	Three-phase 380V-480V, 50/60Hz						
	Rated current ^{*3} [A]	39.0	45.0	60.0	75.0	91.0		
	Overload capacity [A] (Permissible overload time)	78.0 (3s)	90.0 (3s)	120 (3s)	150 (3s)	182 (3s)		
	Rated frequency [Hz]	50, 60Hz						
Input ratings	Main power supply	Normal operation	Phases, Voltage, Frequency	Three-phase, 380 to 480V, 50/60Hz				
			Variations	Voltage: +10 to -15% (Voltage unbalance: 2% or less ^{*4}) Frequency: +5 to -5%				
		Rated current ^{*5} [A]	with DCR	35.5	42.2	57.0	68.5	83.2
			without DCR	52.3	60.6	77.9	94.3	114
		Required power supply capacity (with DCR) [kVA]	25	30	40	48	58	
	UPS operation	Phases, Voltage, Frequency	Single-phase, 220 to 480V, 50/60Hz					
		Variations	Voltage: +10 to -10%, Frequency: +5 to -5%					
	Battery operation	Operation time [s] ^{*14}	180					
		Power Supply Voltage for driving	DC 48V or more in the direct current voltage conversion					
		Operation time [s] ^{*14}	180					
Auxiliary control power supply Voltage		Single-phase 220 to 480V, 50/60Hz ^{*9}						
Braking	Braking time ^{*7} [s]	60						
	Braking duty-cycle (%ED) ^{*7} [%]	50						
	Rated regenerative power ^{*7} [kW]	14.8	17.6	24	29.6	36		
	Minimum resistance which can be connected [Ω] ^{*6}	16	16	10	8.5	8		
EMC filter		Built-in (According to EN12015, EN12016)						
Enclosure (IEC60529)		IP20	IP00					
	Heat sink	IP20	IP00					
Cooling method		Fan cooling						
Average sound pressure level at trip.[dBA] ^{*8}		55	60					
Average power losses [W]	in standstill ^{*12}	26	33					
	in standby ^{*13}	16	18					
Weight/Mass [kg]		10.5	11.2	27	28	32		

*1) Rated capacity is calculated by regarding the output rated voltage as 440V.

*2) Output voltage cannot exceed the power supply voltage.

*3) These values correspond to the following conditions: carrier frequency is 10 kHz (2 phase modulation) and ambient temperature is 45°C.

Select the inverter capacity such that the square average current during operation is not higher than the 80% of the rated current of the inverter.

*4) Voltage unbalance [%] = (Max.voltage [V] - Min.voltage [V]) / Three-phase average voltage [V] x 67 (IEC61800-3)

*5) The power supply capacity is 500kVA (ten times the inverter capacity when the inverter capacity exceeds 50kVA), and the value of the power supply impedance is %X=5%.

*6) The admissible error of minimum resistance is ±5%.

*7) Braking time and duty cycle (%ED) are defined by cycle operation at the rated regenerative power as shown in the figure below.

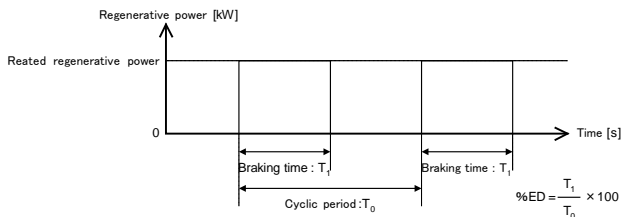

- *8) Measured at 1m from inverter.
- *9) Variations (Voltage: +10 to -10%, Frequency: +5 to -5%)
- *12) Standstill means STBY function is not activated, cooling fan is stopped and inverter is supplied by means of normal power supply (L1/L2/L3).
- *13) Standby means STBY function is activated, cooling fan is stopped and inverter is supplied by a means of auxiliary power supply (15kW or less:+24VDC, 18.5kW or more:400VAC.).
- *14) UPS or Battery operations are available regenerative power mode only. The power running mode is not available.

Specifications for use with three-phase 230V mode ^{*17}

Item		Specifications							
Type FRN	LM2A-4□	0019	0025	0032	0039	0045	0060		
Nominal applied motor [kW]		4.0	5.5	7.5	9.0	11	15		
Output ratings	Rated capacity ^{*1} [kVA]	7.4	9.8	12.7	15.5	17.9	23.9		
	Rated voltage ^{*2} [V]	Three-phase 380V-480V, 50/60Hz							
	Rated current ^{*3} [A]	18.5	24.5	32.0	39.0	45.0	60.0		
	Overload capacity [A] (Permissible overload time)	37.0 (3s)	49.0 (3s)	64.0 (3s)	78.0 (3s)	90.0 (3s)	120 (3s)		
	Rated frequency [Hz]	50, 60Hz							
Input ratings	Main power supply	Normal operation	Phases, Voltage, Frequency	Three-phase, 230V, 50/60Hz					
			Variations	Voltage: +10 to -10% (Voltage unbalance: 2% or less ^{*4}) Frequency: +5 to -5%					
		Rated current ^{*5} [A]	with DCR	14.4	21.1	28.8	34.5	42.2	57.6
			without DCR	23.2	31.5	42.7	49.5	60.6	- ^{*15}
		Required power supply capacity (with DCR) [kVA]	5.7	8.4	11.5	13.7	16.8	22.9	
	UPS operation	Phases, Voltage, Frequency	Single-phase, 220 to 240V, 50/60Hz						
		Variations	Voltage: +10 to -10% ,Frequency: +5 to -5%						
		Operation time [s] ^{*14}	180						
	Battery operation	Power Supply Voltage for driving	DC 48V or more in the direct current voltage conversion.						
		Operation time [s] ^{*14}	180						
Auxiliary control power supply Voltage		DC 24V (22V to 32V), Maximum 40W ^{*16}			Single-phase 230V, 50/60Hz ^{*9}				
Braking	Braking time ^{*7} [s]		60						
	Braking duty-cycle (%ED) ^{*7} [%]		50						
	Rated regenerative power ^{*7} [kW]		3.2	4.4	6.0	7.2	8.8	12	
	Minimum resistance which can be connected [Ω] ^{*6}		24	16	12	8	8	6	
EMC filter		Built-in (According to EN12015, EN12016)							
Enclosure (IEC60529)		IP20			IP20		IP00		
		IP54			IP20		IP00		
Cooling method		Fan cooling							
Average sound pressure level at trip. [dBA] ^{*8}		48	49.5		55		60		
Average power losses [W]		in standstill ^{*12}		23		26			
		in standby ^{*13}		-		16			
Weight/Mass [kg]		4.7	6.1	6.3	10.5	11.2	27		

*1) Rated capacity is calculated by regarding the output rated voltage as 230V.

*2) Output voltage cannot exceed the power supply voltage.

*3) These values correspond to the following conditions: carrier frequency is 10 kHz (2 phase modulation) and ambient temperature is 45°C.

Select the inverter capacity such that the square average current during operation is not higher than the 80% of the rated current of the inverter.

*4) Voltage unbalance [%] = (Max.voltage [V] - Min.voltage [V]) / Three-phase average voltage [V] x 67 (IEC61800-3)

*5) The power supply capacity is 500kVA (ten times the inverter capacity when the inverter capacity exceeds 50kVA), and the value of the power supply impedance is %X=5%.

*6) The admissible error of minimum resistance is ±5%.

*7) Braking time and duty cycle (%ED) are defined by cycle operation at the rated regenerative power as shown in the figure below.

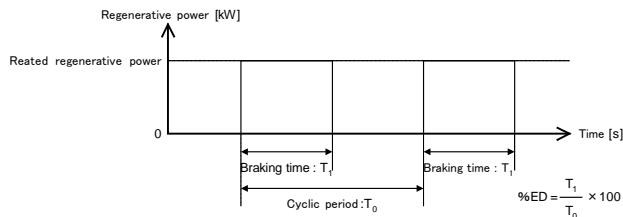

- *8) Measured at 1m from inverter.
- *9) Variations (Voltage: +10 to -10%, Frequency: +5 to -5%)
- *12) Standstill means STBY function is not activated, cooling fan is stopped and inverter is supplied by means of normal power supply (L1/L2/L3).
- *13) Standby means STBY function is activated, cooling fan is stopped and inverter is supplied by a means of auxiliary power supply (9.0kW or more: 230VAC.).
- *14) UPS or Battery operations are available regenerative power mode only. The power running mode is not available.
- *15) DCR is required for 230V mode of FRN0060LM2A-4E.
- *16) Only for rescue operation. Do not use during normal operation.
- *17) 230V mode is available in FRN0019LM2A-4E to FRN0060LM2A-4E with ROM version 1500 or later. Refer to the FRENIC-Lift LM2A series Reference Manual for how to switch to 230V mode.

 WARNING
--

Use the correct combination of power supply, 230V mode and motor. Risk of fire and risk of accidents exist
--

2) Single-phase 200V series

Item		Specifications			
Type	FRN LM2A-7□	0011	0018		
Nominal applied motor [kW]		2.2	4.0		
Output ratings	Rated capacity ^{*1} [kVA]	4.1	6.8		
	Rated voltage ^{*2} [V]	Three-phase 200V-240V, 50/60Hz			
	Rated current ^{*3} [A]	11.0	18.0		
	Overload capacity ^{*4} [A] (Permissible overload time)	22.0 (3s)	36.0 (3s)		
	Rated frequency [Hz]	50, 60Hz			
Input ratings	Main power supply	Normal operation	Phases, Voltage, Frequency	Single-phase, 200 to 240V, 50/60Hz	
			Variations	Voltage: +10 to -15%, Frequency: +5 to -5%	
		Rated current ^{*5} [A]	with DCR	17.5	33
			without DCR	24	41
		Required power supply capacity (with DCR) [kVA]	3.5	6.1	
	UPS operation	Phases, Voltage, Frequency	Single-phase, 200 to 240V, 50/60Hz		
		Variations	Voltage: +10 to -10%, Frequency: +5 to -5%		
		Operation time [s] ^{*14}	180		
	Battery operation	Power Supply Voltage for driving	DC 36V or more in the direct current voltage conversion.		
		Operation time [s] ^{*14}	180		
Auxiliary control power supply Voltage		DC 24V (22V to 32V), Maximum 40W			
Braking	Braking time ^{*7} [s]	60			
	Braking duty-cycle (%ED) ^{*7} [%]	50			
	Rated regenerative power ^{*7} [kW]	1.8	3.2		
	Minimum resistance which can be connected [Ω] ^{*6}	33	20		
EMC filter		Built-in (According to EN12015, EN12016)			
Enclosure (IEC60529)		IP20			
Heat sink		IP54			
Cooling method		Fan cooling			
Average sound pressure level at trip. [dBA] ^{*8}		44.5	48		
Average power losses [W]		in standstill ^{*12}	23		
		in standby ^{*13}	16		
Weight/Mass [kg]		4.1	4.5		

*1) Rated capacity is calculated by regarding the output rated voltage as 220V

*2) Output voltage cannot exceed the power supply voltage.

*3) These values correspond to the following conditions: carrier frequency is 10 kHz (2 phase modulation) and ambient temperature is 45°C.

Select the inverter capacity such that the square average current during operation is;

- For FRN0011LM2A-7: Up to the 80% of the rated current of the inverter.

- For FRN0018LM2A-7: Up to the 70% of the rated current of the inverter.

*4) With DCR. Without DCR, overload capacity is 150%, 3s.

*5) The power supply capacity is 500kVA and the value of the power supply impedance is %X=5%.

*6) The admissible error of minimum resistance is ±5%.

*7) Braking time and duty cycle (%ED) are defined by cycle operation at the rated regenerative power as shown in the figure below.

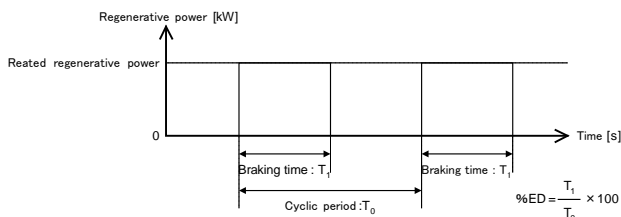

*8) Measured at 1m from inverter.

*12) Standstill means STBY function is not activated, cooling fan is stopped and inverter is supplied by means of normal power supply (L1/L2).

*13) Standby means STBY function is activated, cooling fan is stopped and inverter is supplied by a means of auxiliary power supply (+24VDC).

*14) UPS or Battery operations are available regenerative power mode only. The power running mode is not available.

7.2 External Dimensions

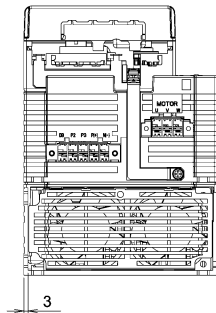
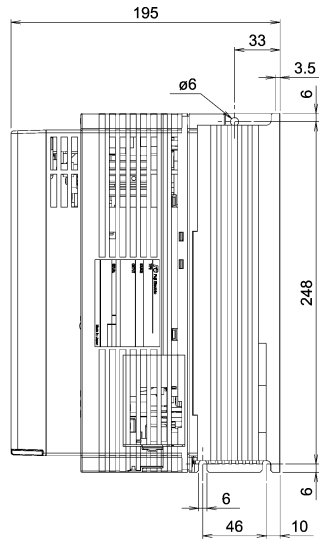
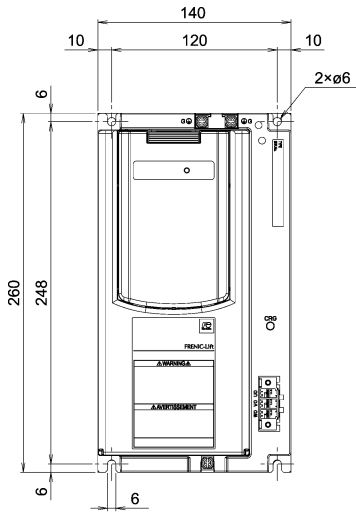

Power supply voltage	Inverter type
Three-phase 400V	FRN006LM2A-4□
	FRN0010LM2A-4□
	FRN0015LM2A-4□
	FRN0019LM2A-4□
Single-phase 200V	FRN0011LM2A-7□
	FRN0018LM2A-7□

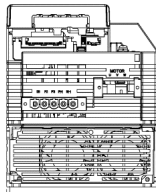
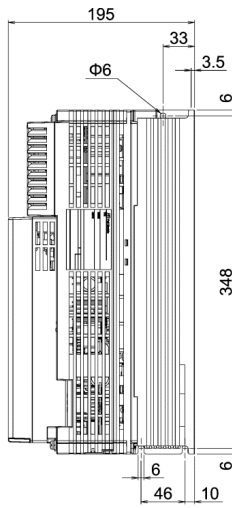
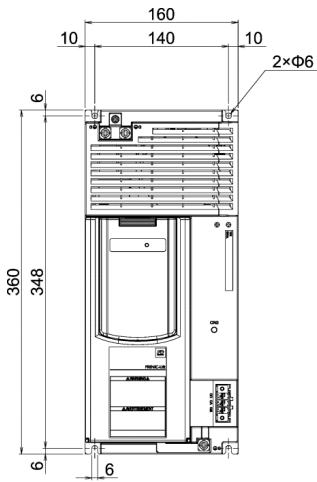

Power supply voltage	Inverter type
Three-phase 400V	FRN0025LM2A-4□
	FRN0032LM2A-4□

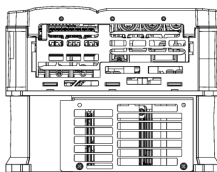
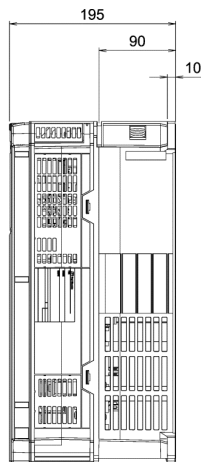
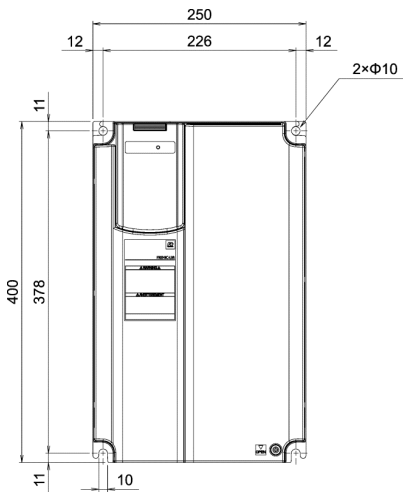

Power supply voltage	Inverter type
Three-phase 400V	FRN0039LM2A-4□
	FRN0045LM2A-4□

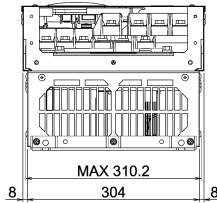
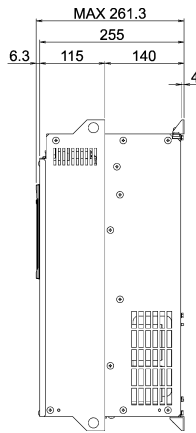
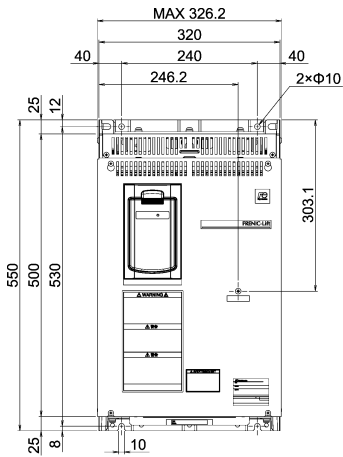

Power supply voltage	Inverter type
Three-phase 400V	FRN0060LM2A-4□
	FRN0075LM2A-4□

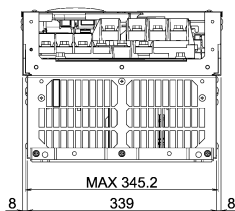
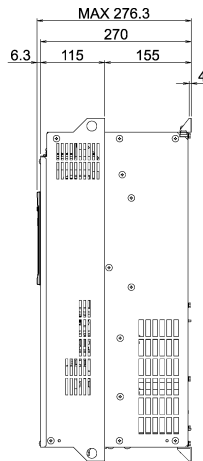
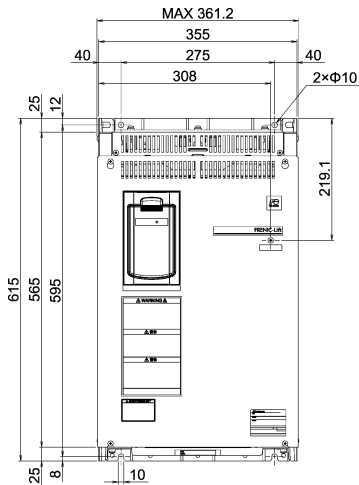

Power supply voltage	Inverter type
Three-phase 400V	FRN0091LM2A-4□

Chapter 8 CONFORMITY WITH STANDARDS

8.1 Compatibility with Revised EMC Directive and Low Voltage Directive

In the revised EMC Directive (2014/30/EU) and Low Voltage Directive (2014/35/EU), it is necessary to clearly state the name and the address of manufacturers and importers to enhance traceability. Importers shall be indicated as follows when exporting products from Fuji Electric to Europe.

(Manufacturer)

Fuji Electric Co., Ltd
5520, Minami Tamagaki-cho, Suzuka-city, Mie 513-8633, Japan

(Importer in Europe)

Fuji Electric Europe GmbH
Goethering 58, 63067 Offenbach / Main, Germany

<Precaution when exporting to Europe>

- Not all Fuji Electric products in Europe are necessarily imported by the above importer. If any Fuji Electric products are exported to Europe via another importer, please ensure that the importer is clearly stated by the customer.

8.2 Compliance with European Standards

The CE marking on Fuji products indicates that they comply with the essential requirements of the Electromagnetic Compatibility (EMC) Directive, Low Voltage Directive, Machinery Directive and Lift Directive which are issued by the Council of the European Communities.

 **Note** The amount of current leaked by internal EMC-compatible filter is significantly large, and therefore a check should be performed to determine whether the power supply system is affected.

 Refer to Chapter 8.4.3 below for details on EMC filter leakage current values.

The products comply with the following standards

Table 8.1 Product Standards Compliance

	FRN0011LM2A-7□, FRN0018LM2A-7□	FRN0006LM2A-4□ to FRN0025LM2A-4□	FRN0032LM2A-4□ to FRN0091LM2A-4□
Low Voltage Directive	IEC/EN 61800-5-1		
EMC Directives	IEC/EN 61800-3 Immunity : Second environment (Industrial) Emission: Category C2		IEC/EN 61800-3 Immunity : Second environment (Industrial) Emission: Category C3
	IEC/EN 61326-3-1		
Machinery Directive	EN ISO 13849-1	:Cat. 3 / PL=e	
	IEC/EN 61508-1 to -7	:SIL3	
	IEC/EN 61800-5-2	:SIL3 , Safety function: Safe Torque Off (STO)	
	IEC/EN 62061	:SILCL3	
Lift Directive	EN 81-20 (in extract), EN 81-50 (in extract) EN 12015, EN 12016		

Note

A box (□) replaces an alphabetic letter depending on the shipping destination.

□Shipping destination: E (Europe) or A (Asia)

8.3 Conformity to the Low Voltage Directive in the EU

To use Fuji inverters as a product conforming to the Low Voltage Directive in the EU, refer to guidelines given on pages vi to viii.

8.4 Compliance with EMC Standards

8.4.1 General

The CE marking on inverters does not ensure that the entire equipment including our CE-marked products is compliant with the EMC Directive. Therefore, CE marking for the equipment shall be the responsibility of the equipment manufacturer. For this reason, Fuji Electric's CE mark is indicated under the condition that the product shall be used within equipment meeting all requirements for the relevant Directives. Instrumentation of such equipment shall be the responsibility of the equipment manufacturer.

Generally, machinery or equipment includes not only our products but other devices as well. Manufacturers, therefore, shall design the whole system to be compliant with the relevant Directives.



EMC certification testing is performed using the following wiring distances between the inverter and motor (shielded wire):

- FRN0006LM2A-4□ to FRN0091LM2A-4□ : 10 m
- FRN0011LM2A-7□, FRN0018LM2A-7□

8.4.2 Recommended installation procedure

To make the machinery or equipment fully compliant with the EMC Directive, the motor and inverter have to be wired by certified technicians in strict accordance with the procedure given below.

- 1) Use shielded wires for the motor cable and route the cable as short as possible. Firmly clamp the shield to the specified point or the grounded metal plate inside the inverter. Further, connect the shielding layer electrically to the grounding terminal of the motor.
- 2) For connection to inverter's control terminals and for connection of the RS-485 communication or CAN-BUS signal cable, use shielded wires. Clamp the shields firmly to the grounded metal plate.
- 3) Place the inverter on a grounded metal plate such as the surface of a panel, as shown in Figure 8.1. If radiated noise emissions exceed the standard, place the inverter and any peripheral equipment inside a metal control panel.

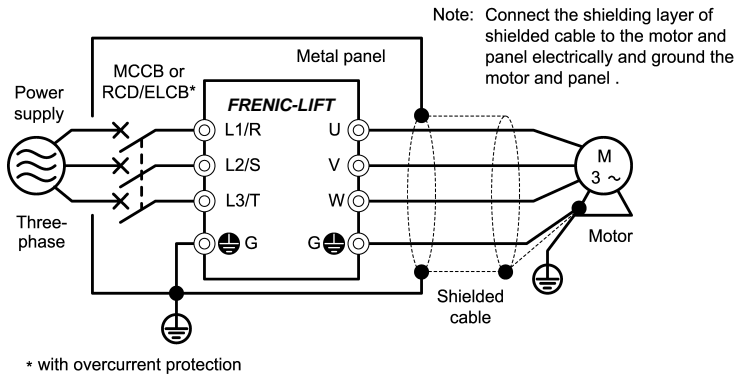

Figure 8.1 Installation inside a Panel

- 4) If radiated noise emissions exceed the requirement by the standard, place a ferrite core on the input side of the inverter, as shown in Figure 8.2.

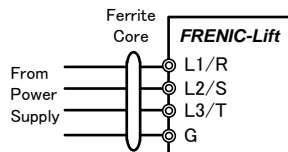

Figure 8.2 Installation for ferrite core

8.4.3 Leakage current of the EMC filter

This product has built-in EMC compliant filter that contains grounding capacitors for noise suppression which increase the leakage current. Check whether there is no problem with electrical systems. When using this product, the leakage current listed in Table 8.2 is added. Before adding this product, consider whether the additional leakage current is allowable in the context of the overall system design.

Table 8.2 Leakage Current of FRENIC Lift

Input power	Inverter type	Leakage current (mA)	Input power	Inverter type	Leakage current (mA)
Three-phase 400 V	FRN0006LM2A-4□	15	One-phase 200 V	FRN0011LM2A-7□	15
	FRN0010LM2A-4□			FRN0018LM2A-7□	
	FRN0015LM2A-4□		3		
	FRN0019LM2A-4□				
	FRN0025LM2A-4□				
	FRN0032LM2A-4□		8		
	FRN0039LM2A-4□				
	FRN0045LM2A-4□				
	FRN0060LM2A-4□				
		FRN0075LM2A-4□			
		FRN0091LM2A-4□			

* Calculated based on these measuring conditions

400V series: 400V, 50Hz with neutral grounding, and an interphase voltage unbalance ratio of 2%.

200V series: 230V, 50Hz with phase grounding.

Note: A box (□) replaces an alphabetic letter depending on the shipping destination.

□Shipping destination: E (Europe) or A (Asia)

8.5 Harmonic Component Regulation in the EU

8.5.1 General comments

When general-purpose industrial inverters are used in the EU, the harmonics emitted from inverters to the power lines are strictly regulated as stated below.

If an inverter whose rated input is 1 kW or less is connected to the public low-voltage power supply, it is regulated by the harmonics emission regulation IEC/EN 61000-3-2. If an inverter whose input current is above 16 A and 75 A or below is connected to the public low-voltage power supply, it is regulated by the harmonics emission regulation IEC/EN 61000-3-12.

Note that connection to the industrial low-voltage power lines is an exception. See Figure 8.3.

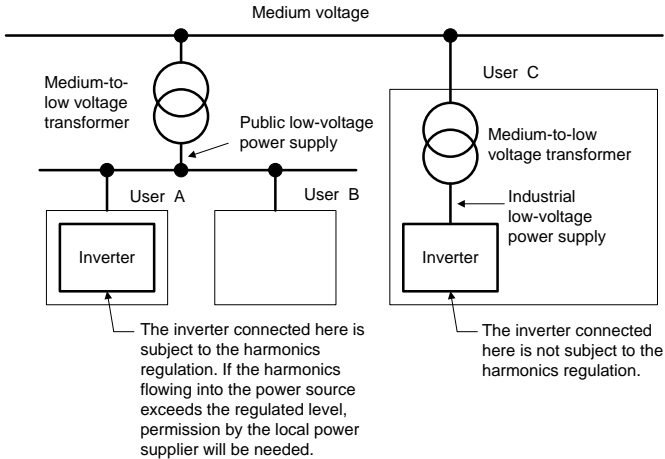

Figure 8.3 Power Source and Regulation

8.5.2 Compliance with IEC/EN 61000-3-12

To bring the inverters FRN0006LM2A-4□ to FRN0091LM2A-4□ into compliance with IEC/EN 61000-3-12, install an optional DC reactor and connect the inverters to a power supply whose short-circuit ratio R_{sce} is 120 or above.

8.6 Compliance with Functional Safety Standard

8.6.1 General

In FRENIC-Lift series of inverters, opening the hardware circuit between terminals [EN1]-[PLC] or between terminals [EN2]-[PLC] stops the output transistor, coasting the motor to a stop (EN: Enable input). This is the Safe Torque Off (STO) compliant with Functional Safety Standard EN/IEC 61800-5-2.

Using the Safe Torque Off (STO) function eliminates the need of external safety circuit breakers (i.e. magnetic contactors) while conventional inverters need those breakers to set up the system compliant to Functional Safety Standard.

Table 8.3 shows the functional safety function performance.

Table 8.3 Functional Safety Function Performance

EN ISO 13849-1		
	Category	3
	Performance level	e
	DCave	>= 90% (medium)
	Response time (Safety reaction time)	<= 50 ms (Delay time from when either of terminals [EN1] and [EN2] comes OFF to STO)
	MTTFd for each channel	>= 30 years
EN 61508-1 to -7 EN 61800-5-2		
	Safety Function (Stop function)	STO (Safe Torque Off)
	SIL (Safety integrity level)	SIL3 (Type B)
	HFT (Hardware Fault Tolerance)	1
	SFF (Safe Failure Fraction)	>= 90%
	PFDave	< 1.0×10^{-3} (Average of Probability of Failure on Demand)
	PFH	< 1.0×10^{-7} (Probability of a dangerous random hardware failure per hour)
	Proof test interval	20 years



WARNING



- The output shutdown function of this inverter uses the Safe Torque Off (STO) function prescribed in IEC/EN 61800-5-2 so that it does not completely shut off the power supply to the motor electrically. Depending upon applications, therefore, additional measures are necessary for safety of end-users, e.g., brake function that locks the machinery and motor terminal protection that prevents possible electrical hazard(s).
- The output shutdown function does not completely shut off the power supply to the motor electrically. Before starting wiring or maintenance jobs, therefore, be sure to disconnect the input power to the inverter and wait at least five minutes.
- When a permanent magnet synchronous motor (PMSM) is coasting to a stop caused by the output shutdown function, voltage is applied to its terminals. Before starting maintenance, inspection or wiring, therefore, be sure to check that the PMSM is completely stopped.
An electric shock could occur.

Enable terminals and peripheral circuit, and internal circuit configuration

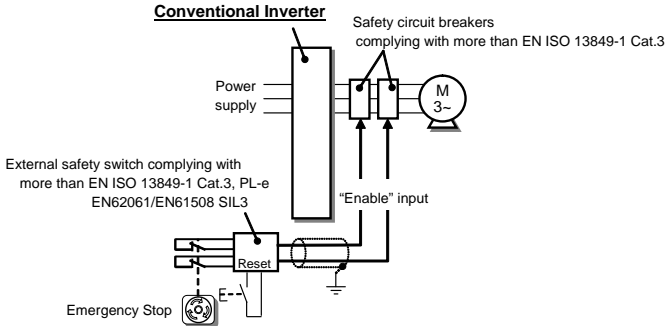
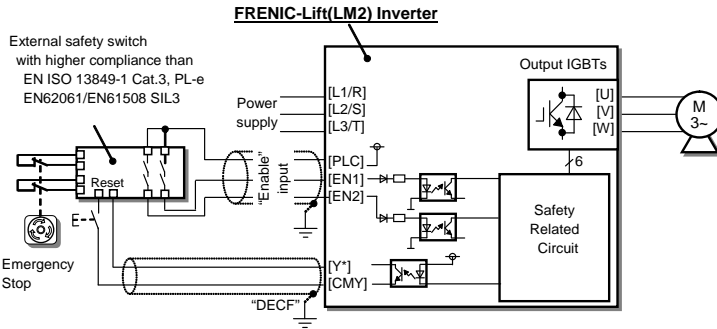

Figure 8.4 Conventional Inverters compliant with EN81-20 5.9.2.5.4 d) or EN81-20 5.9.3.4.2 d)



Note) Y* terminal set to DECF function..

Figure 8.5 FRENIC-Lift Inverters compliant with EN81-20 5.9.2.5.4 d) or EN81-20 5.9.3.4.2 d)

⚠ WARNING ⚡

Take the following measures for synchronous motor drive.

- If a PMSM is rotated with an external force, separate the PMSM and inverter with a switching device, or short PMSM output terminal U, V, and W.
- If a PMSM is rotated with an external force, there is a risk that the inverter will be damaged by energy generated by the motor side.

Risk of breakage.

Table 8.4 Operation of STO Functional Safety Function

Digital input signals		Alarm <i>ECF</i>	Digital output signal	Inverter status
[EN1]	[EN2]		[Y*] (<i>DECF</i>)	
Shorted	Shorted	No issue	ON	Ready to run
		Issue	OFF	Output shutdown (STO)
Opened	Opened	No issue	ON	Output shutdown (STO)
		Issue	OFF	Output shutdown (STO)
Shorted	Opened	Issue	OFF	Output shutdown (STO)
Opened	Shorted	Issue	OFF	Output shutdown (STO)

8.6.2 Notes for compliance to Functional Safety Standard

- 1) Wiring for terminals [EN1] (Enable input 1) and [EN2] (Enable input 2)
 - [EN1]/[EN2] and [PLC] are terminals prepared for connection of safety related wires; therefore, careful wiring should be performed to ensure that no short-circuit(s) can occur to these terminals.
 - For opening and closing the hardware circuit between terminals [EN1]/[EN2] and [PLC], use safety approved components such as safety switches and safety relays that comply with EN ISO13849-1 Cat. 3 PL=e or higher to ensure a complete shutoff.
 - Input cables of [EN1] and [EN2] must be segregated in different electrical conductors installed inside different conduits, otherwise the use of independent shielded cables is a must. The armor of the conduit or the shield must be connected to CM terminal.
 - It is the responsibility of the machinery manufacturer to guarantee that a short-circuiting or other fault does not occur in wiring of external safety components between terminals [EN1]/[EN2] and [PLC].

Fault Examples:

- Terminals [EN1]/[EN2] and [PLC] are short-circuited due to the wiring being caught in the door of the control panel so that a current continues to flow in terminal [EN1]/[EN2] although the safety component is OFF and therefore the safety function will/may NOT operate
- The wiring is in contact with any other wire so that a current continues to flow in terminal [EN1]/[EN2] and therefore the safety function will/may NOT operate

- 2) Notes for Safe Torque Off (STO) function

- When configuring the product safety system with this Safe Torque Off (STO) function, make a risk assessment of not only the external equipment and wiring connected to terminals [EN1] and [EN2] (Enable input 1 and Enable input 2) but also the whole system including other equipment, devices and wiring against the product safety system required by the machinery manufacturer under the manufacturer's responsibility in order to confirm that the whole system conforms to the product safety system required by the machinery manufacturer.

In addition, as preventive maintenance, the machinery manufacturer must perform periodical inspections to check that the product safety system properly functions.

- Inverter is designed according to Pollution Degree 2 environment. If the inverter is installed inside a worse environment (for example, Pollution Degree 3 environment), the inverter may be damaged. Even though,

under Pollution Degree 3 environment the safety circuit that implements the STO functional safety function will not reduce its performance. Therefore, the STO function operation can be ensured even under Pollution Degree 3.

- To bring the inverter into compliance with Functional Safety Standard, it is necessary to bring it into compliance with European Standards EN61800-5-1 and EN61800-3.
- This Safe Torque Off (STO) function coasts the motor to a stop.
- In case of diagnostics with a safe PLC, short pulses with a duration less than 1 ms should be input to terminals [EN1] and [EN2].
- The safety shutdown circuit between input terminals [EN1] and [EN2] sections and inverter's output shutdown section is a redundant circuit so that an occurrence of a single fault does not prevent the Safe Torque Off (STO) function.

If a single fault is detected in the safety shutdown circuit, the inverter coasts the motor to a stop even with the terminal [EN1]-[PLC] and [EN2]-[PLC] states being ON, as well as outputting an alarm to external equipment. Note that the alarm output function is not guaranteed to all of single faults. It is compliant with EN ISO13849-1 Cat. 3 PL=e.

- This Safe Torque Off (STO) function may not completely shut off the power supply to the motor electrically. Before starting wiring or maintenance jobs, be sure to disconnect the input power to the inverter and wait at least 5 minutes.

3) Test of Safe Torque Off (STO) function

- [EN1]/[EN2] and [PLC] must be turned off for diagnostics at least one time per hour. Then [EN1]/[EN2] and [PLC] must be kept off for at least 2 seconds.
- Main power supply must be shut off (auxiliary power supply of the control circuit can be supplied) at least one time per year.

8.6.3 Inverter output state when Safe Torque Off (STO) is activated

Turning the emergency stop button ON turns EN1 and EN2 OFF, bringing the inverter into the Safe Torque Off (STO) state.

Figure 8.6 shows the timing scheme to apply when the emergency stop button is turned OFF with the inverter being stopped. Input signals to EN1 and EN2 become ON, making the inverter ready to run.

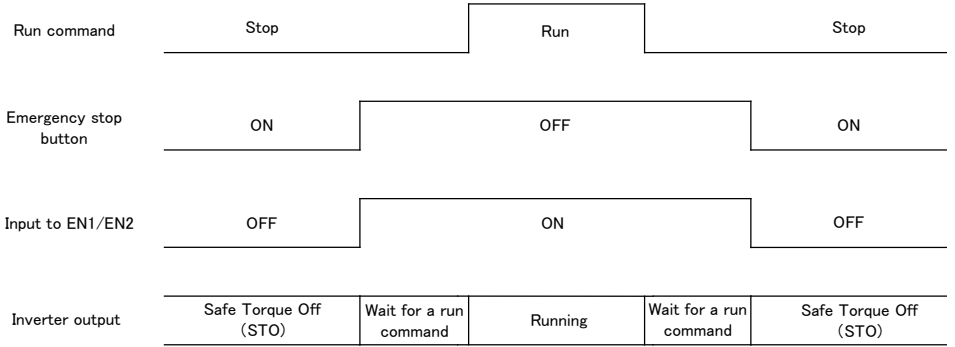

Figure 8.6 Inverter Output State when the Emergency Stop Button is Turned OFF with the Inverter Being stopped

Figure 8.7 shows the timing scheme to apply when the emergency stop button is turned ON with the inverter running. Input signals to EN1 and EN2 go OFF, bringing the inverter into the Safe Torque Off (STO) state and coasting the motor to a stop.

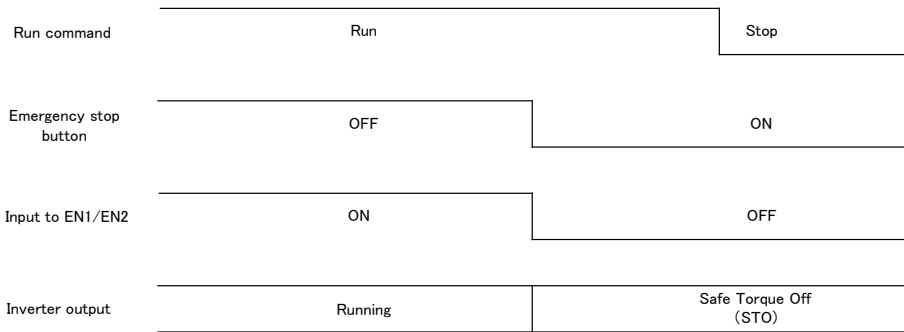

Figure 8.7 Inverter Output State when the Emergency Stop Button is Turned ON with the Inverter Running

8.6.4 ECF alarm (caused by logic discrepancy) and inverter output state

Figure 8.8 shows the timing scheme to apply when EN1 and EN2 inputs are not concordant, so that an alarm ECF occurs.

Turning the emergency stop button ON turns EN1 and EN2 inputs OFF, which usually brings the inverter into the Safe Torque Off (STO) state. If the discrepancy of the EN1 and EN2 inputs is within 50 ms, no alarm occurs; if it is longer than 50 ms, the inverter interprets it as a logic discrepancy, outputting the alarm ECF. The alarm can be cleared by restarting the inverter.

To diagnose the EN terminals circuit appropriately, when turning EN1/EN2 inputs ON and OFF, keep the ON and OFF time for at least 2 s.

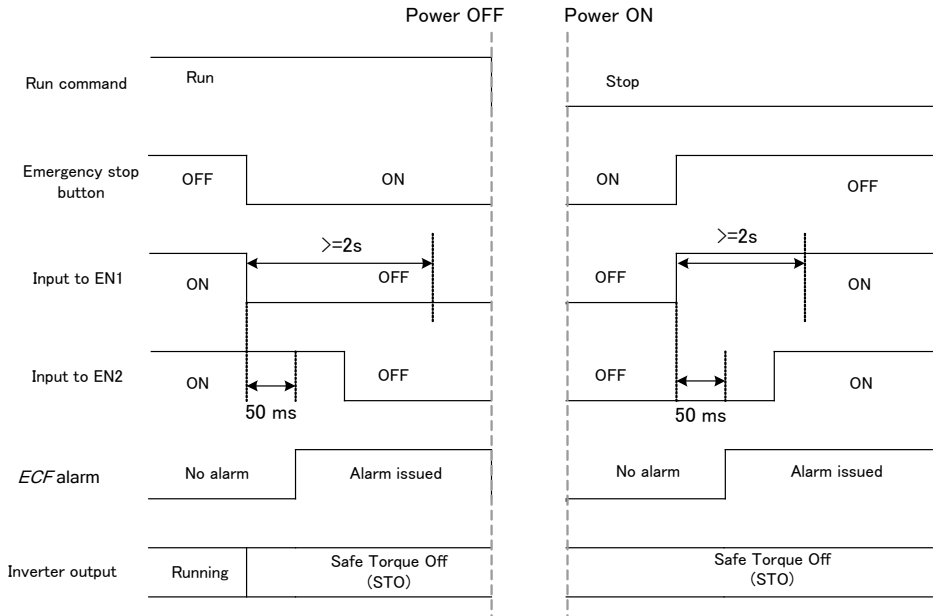

Figure 8.8 ECF Alarm (Caused by Logic Discrepancy) and Inverter Output State

8.7 Compliance with Canadian and U.S. Standards (CSA certification)

8.7.1 General

The inverters with CSA “C/US” marking are certified for both U.S. and Canadian markets, to the applicable U.S. and Canadian standards.

The products comply with the following standards

Table 8.5 Product Standards Compliance

	FRN0006LM2A-4□ to FRN0091LM2A-4□	FRN0011LM2A-7□, FRN0018LM2A-7□
Canadian standards	CSA C22.2 No.274-17 : Adjustable speed drives	
U.S. standards	UL 508 C (3rd Edition) : Power Conversion Equipment	

Note

A box (□) replaces an alphabetic letter depending on the shipping destination.

□Shipping destination: E (Europe) or A (Asia)

8.7.2 Considerations when using FRENIC-Lift (LM2A) in systems to be certified by CSA

If you want to use the FRENIC-Lift (LM2A) of inverters as a part of U.S. and Canadian standards certified product, refer to the related guidelines described on pages ix to xi.

FRENIC-Lift

Instruction Manual

First Edition, February 2015
Seventh Edition, November 2020
Fuji Electric Co., Ltd.

The purpose of this instruction manual is to provide accurate information in handling, setting up and operating of the FRENIC-Lift LM2A series of inverters. Please feel free to send your comments regarding any errors or omissions you may have found, or any suggestions you may have for generally improving the manual.

In no event will Fuji Electric Co., Ltd. be liable for any direct or indirect damages resulting from the application of the information in this manual.

Fuji Electric Co., Ltd.

Gate City Ohsaki, East Tower, 11-2, Osaki 1-chome, Shinagawa-ku, Tokyo 141-0032, Japan

Phone: +81 3 5435 7058 Fax: +81 3 5435 7420

URL <http://www.fujelectric.com/>
